

# Yazoo 2

## Activity Book

Unit	Page	Unit	Page
Alphabet Aa–Zz	2	<b>7a</b> There's a town.	48
Numbers 1–20	4	<b>7b</b> Where's Chatter?	50
Colours	5	<b>7c</b> Skills: My town	52
<b>1a</b> It's a school!	6	<b>8a</b> She can sing.	54
<b>1b</b> Spell 'octopus'.	8	<b>8b</b> Can you skip?	56
<b>1c</b> Skills: My classroom	10	<b>8c</b> Story: Where's my mobile phone?	58
<b>2a</b> Cars and dolls	12	Science	60
<b>2b</b> That's a robot!	14	Review 4	61
<b>2c</b> Story: The frogs!	16	<b>9a</b> We like breakfast.	62
Social Science	18	<b>9b</b> Patty likes fish.	64
Review 1	19	<b>9c</b> Skills: What's on the menu?	66
<b>3a</b> She's pretty.	20	<b>10a</b> He gets up at seven o'clock.	68
<b>3b</b> Is he your grandpa?	22	<b>10b</b> Does Rob go to the zoo every day?	70
<b>3c</b> Skills: My family	24	<b>10c</b> Story: Superboy!	72
<b>4a</b> We're cowboys.	26	Social Science	74
<b>4b</b> Are we pirates?	28	Review 5	75
<b>4c</b> Story: The grey duck	30	<b>11a</b> I'm playing a game.	76
Maths	32	<b>11b</b> They're having a shower.	78
Review 2	33	<b>11c</b> Skills: Me and my friends	80
<b>5a</b> It's his kite.	34	<b>12a</b> They aren't swimming.	82
<b>5b</b> They're our toys.	36	<b>12b</b> Are they sleeping?	84
<b>5c</b> Skills: Our favourite toys	38	<b>12c</b> Story: Jane and the giant	86
<b>6a</b> She's got a pet.	40	Social Science	88
<b>6b</b> Has it got wings?	42	Review 6	89
<b>6c</b> Story: Sam, the circus boy!	44	My Picture Dictionary	90
Science	46	Cut outs	99
Review 3	47		

1 Look and circle.

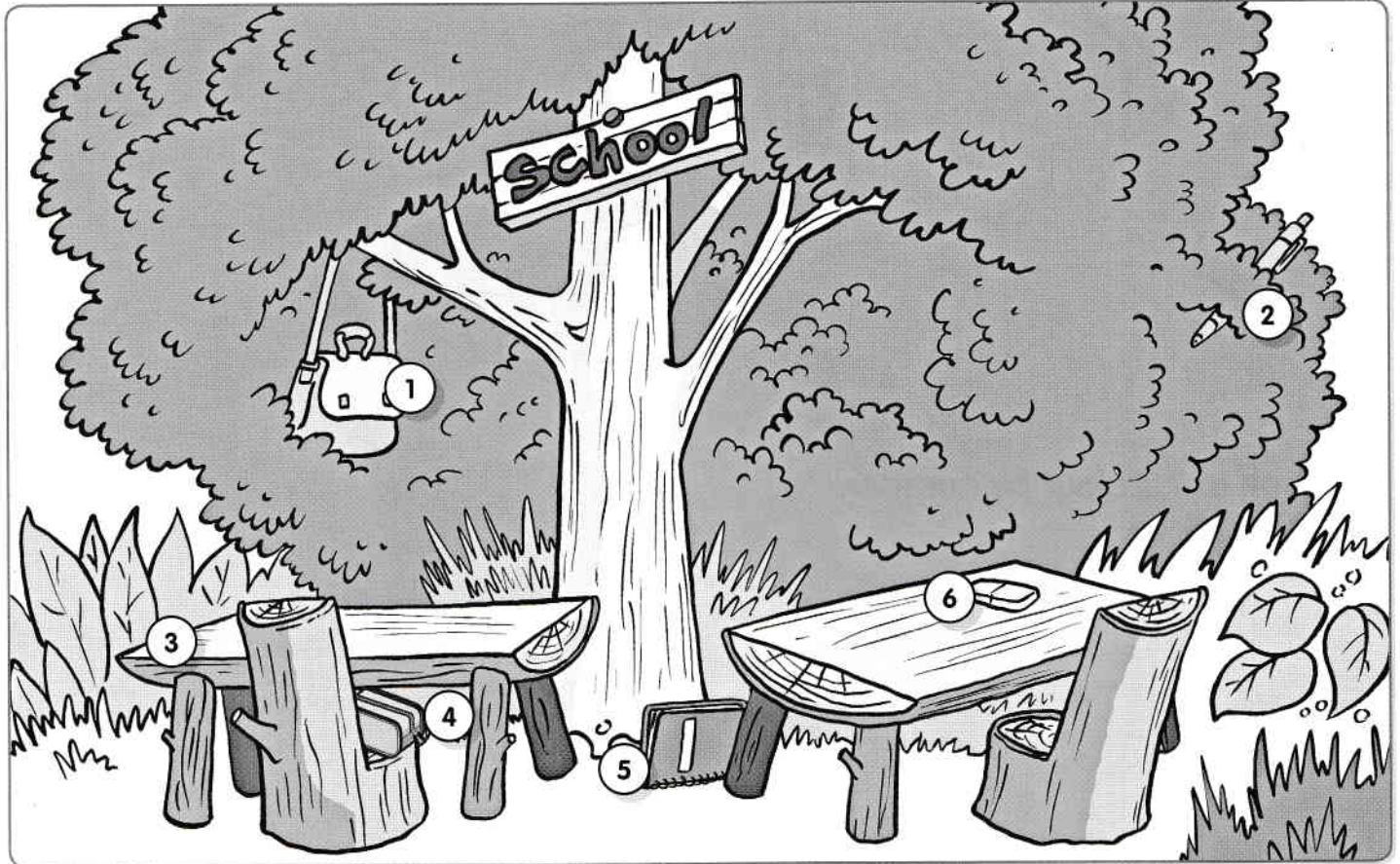

What's this?

- |                             |                                  |
|-----------------------------|----------------------------------|
| 1 It's a bag / pencil case. | 4 It's a pencil case / pencil.   |
| 2 It's a rubber / pen.      | 5 It's a notebook / pencil case. |
| 3 It's a desk / bag.        | 6 It's a bag / rubber.           |

2 Find and circle.

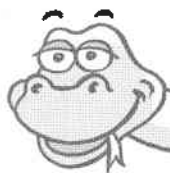

bag pencil case pen rubber notebook desk

3 Read and match.

pencil

octopus

rubber

desk

umbrella

apple

bag

elephant

notebook

insect

a

an

4 Look and write.



1 What's this?  
It's a pencil.



2 What's this?  
It's \_\_\_\_\_.

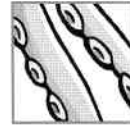

3 What's this?  
It's \_\_\_\_\_.



4 What's this?  
It's \_\_\_\_\_.



5 What's this?  
It's \_\_\_\_\_.

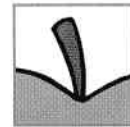

6 What's this?  
It's \_\_\_\_\_.

# Spell 'octopus'.

1 Look and match.

bag

notebook

board

pencil

ruler

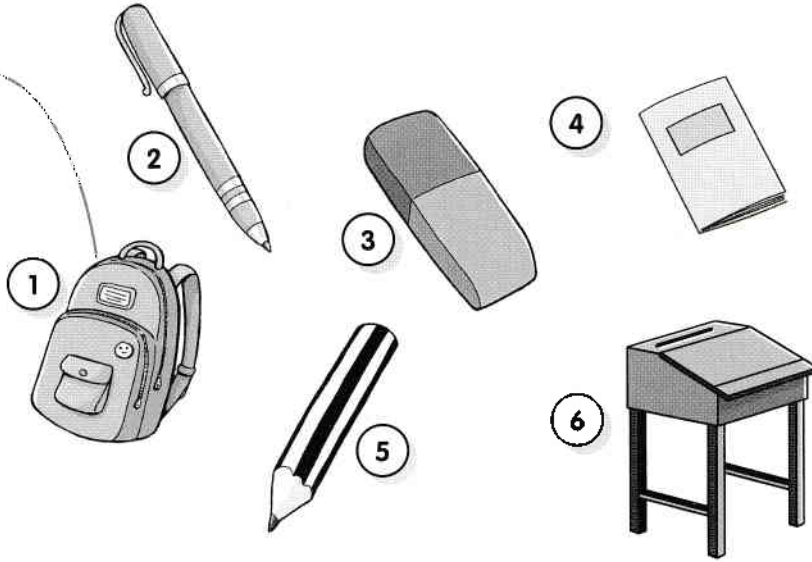

pen

rubber

desk

chair

2 What's missing in 1? Draw and write.

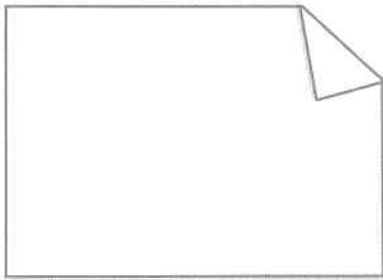

1 \_\_\_\_\_

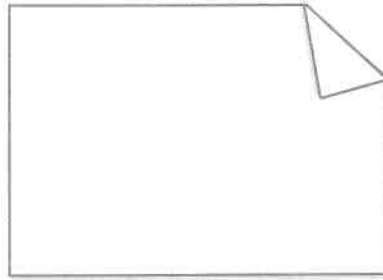

2 \_\_\_\_\_

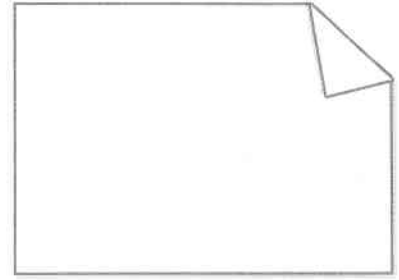

3 \_\_\_\_\_

3 Look and match.

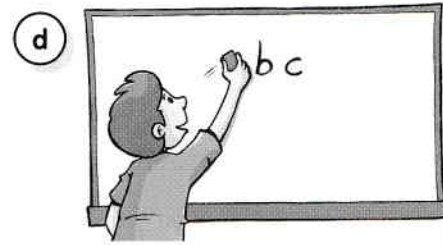
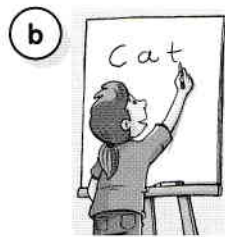
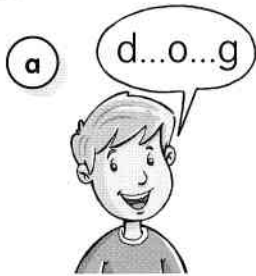

1 Be quiet, please.

2 Clean the board, please.

3 Spell 'dog', please.

4 Write 'cat', please.

4 Listen and colour. ☺)

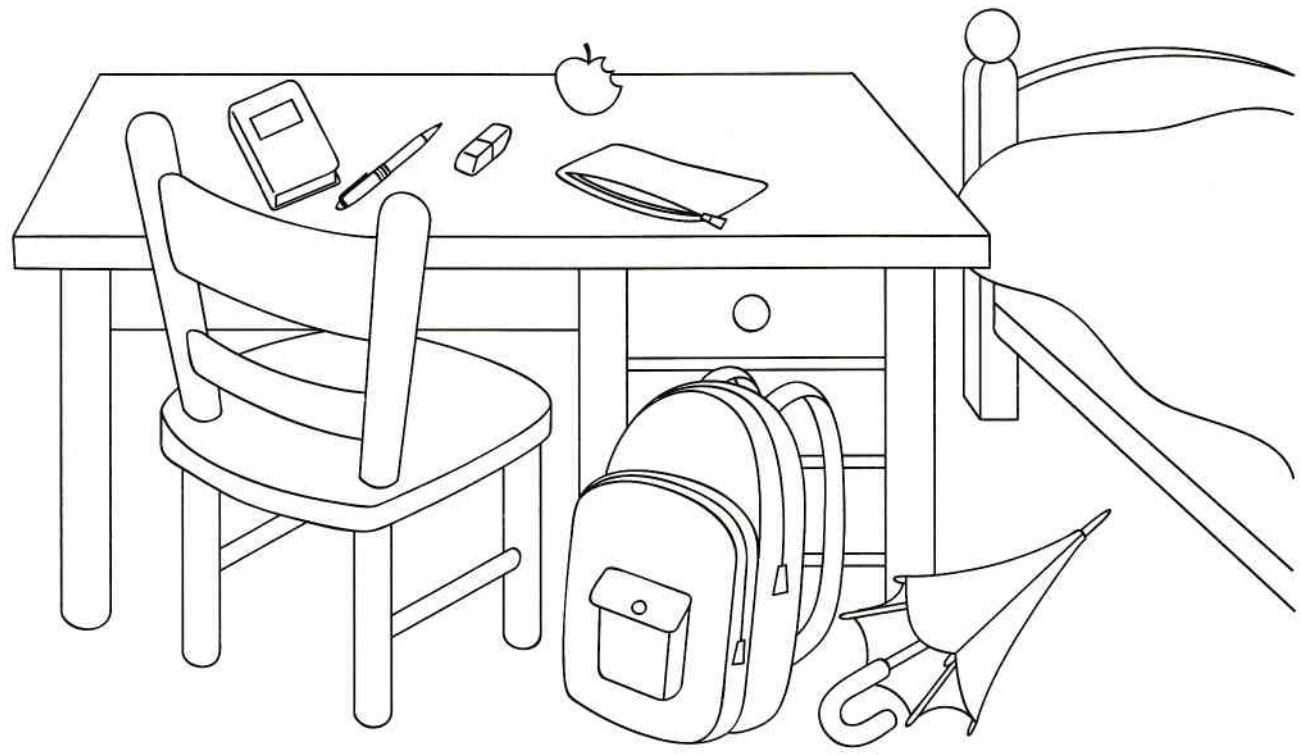
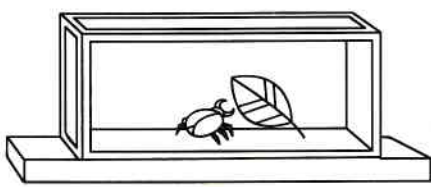

5 Read and circle. Then colour.

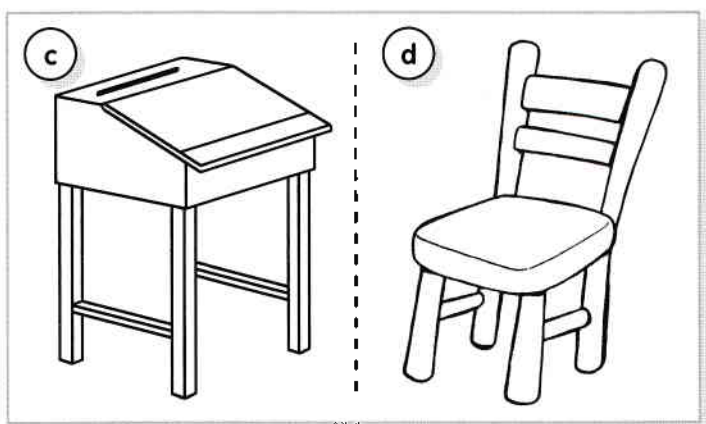
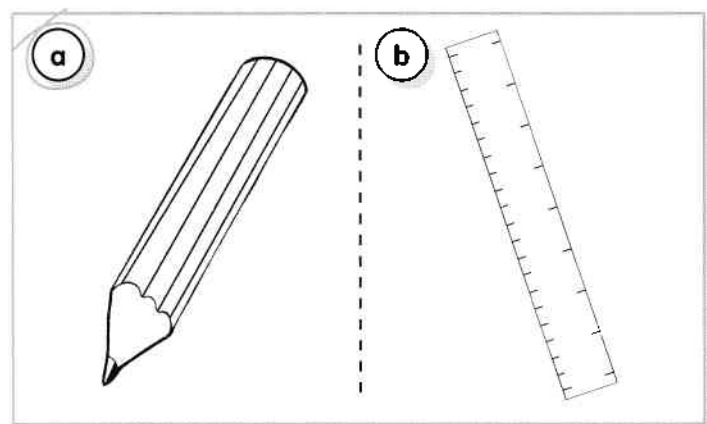

1 What's this?  
It's a pencil.  
What colour is it?  
It's pink and grey.

2 What's this?  
It's a chair.  
What colour is it?  
It's brown and green.