

HYDRAULIC BOXERS

327 PIESE

BOXERII HIDRAULICI



MARIME



ESCHIVA



KNOCK OUT

INSTRUCTIUNI DE ASAMBLARE, PAS CU PAS

8+

Buki
France

CONTINUT



P1

x 4



P2

x 4



P3

x 4



P4

x 4



36 CM

P5

x 6



P6

x 1

PIESE DETASABILE

A x 1

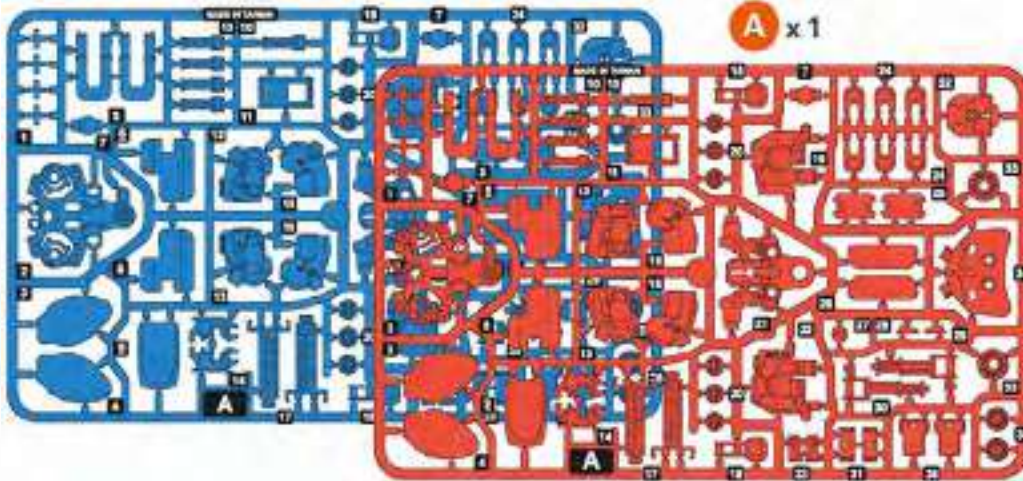

B x 2

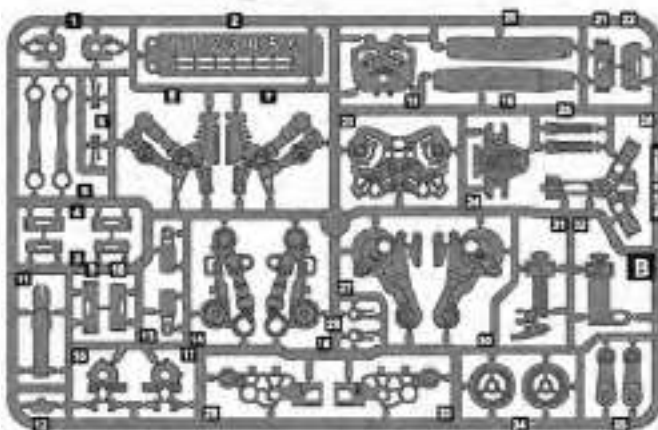

C x 2

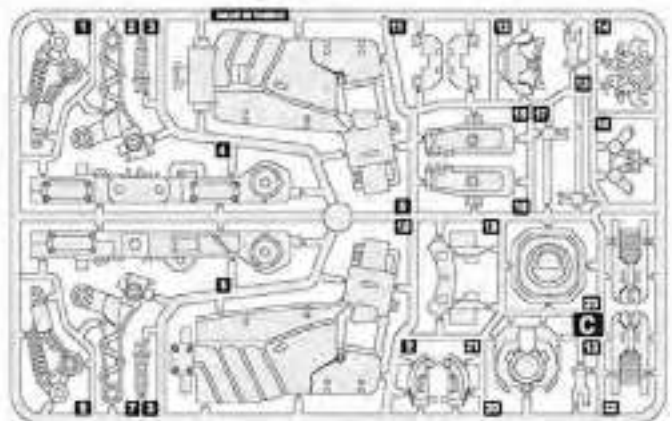

D x 2



- P1 -Capac negru
- P2 -Capac rosu mic
- P3 - Capac rosu mare
- P4- Arc
- P5 -Tub
- P6 -Ulei (Nu manipulați în același timp cu tubul)

INSTRUMENTE SUPLIMENTARE NECESARE



CLESTE DE
TAIAT



MARKER



PAHAR



RIGLA

RECOMANDARI



1

Puteți identifica piesele folosind numerele de pe foi. Detașați piesele când aveți nevoie de ele, în timp ce urmați pașii din instrucțiuni.

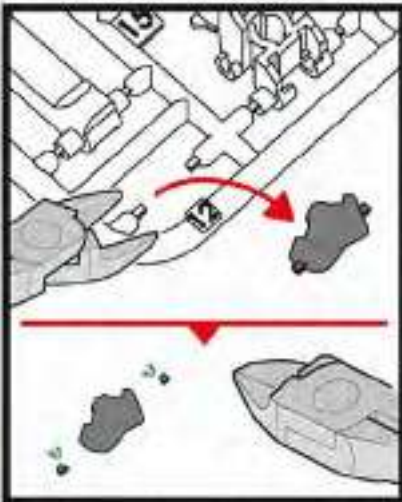
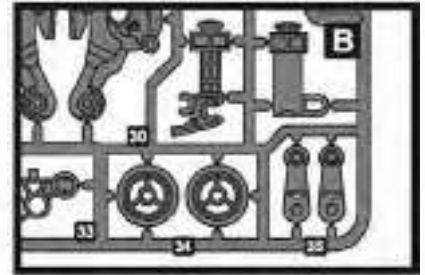

2

Cereți unui adult să taie toate piciorusele de legatura înainte de a asambla piesele. Pe anumite părți, asigurați-vă că tăiați doar acele picioruse.

3

Important: anumite piese arată similar. Urmăriți cu atenție direcția de asamblare.



4

Citiți cu atenție instrucțiunile și urmați pașii de asamblare în ordinea corectă.



CONTINUT

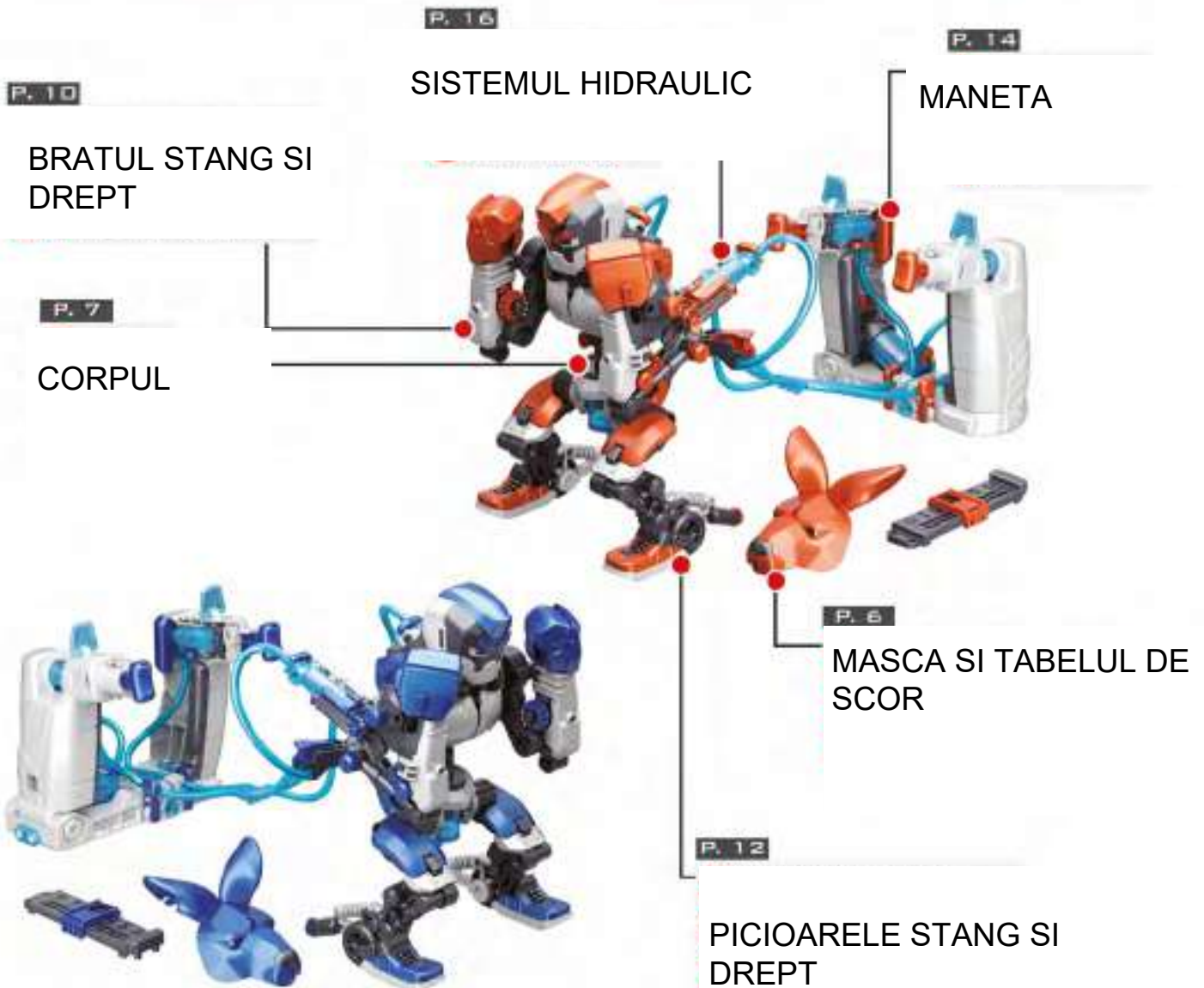

De la pagina 6 pana la pagina 30 regasiti instructiuni de asamblare a boxerului portocaliu. Urmati aceiasi pasi si pentru luptatorul de culoare albastra. Salvati timp daca asamblati roboteii in acelasi timp cu altcineva.

Timp de asamblare



A



B

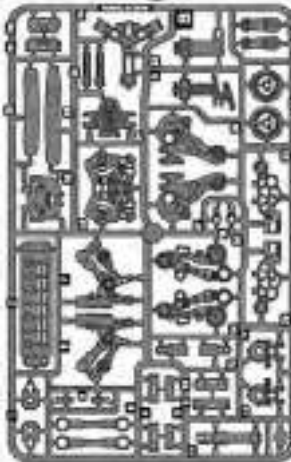

C

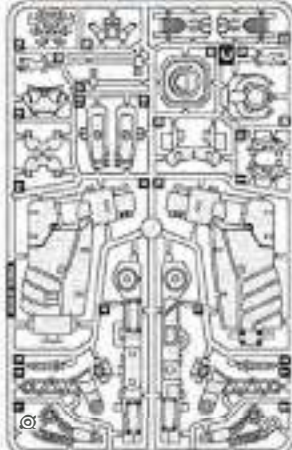

D



P1
• •

P2
• •

P3
• •

P4
• •

P5

A



B

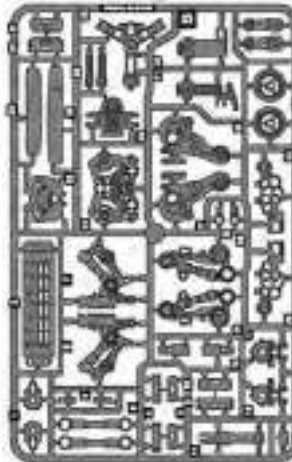

C

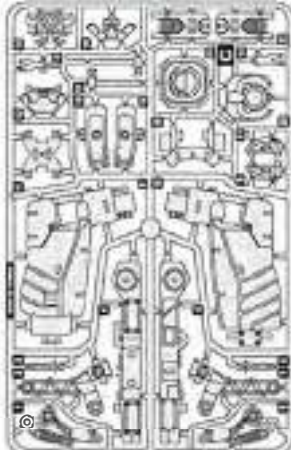

D



P1
• •

P2
• •

P3
• •

P4
• •

P5



TABELUL DE SCOR



1



MASCA

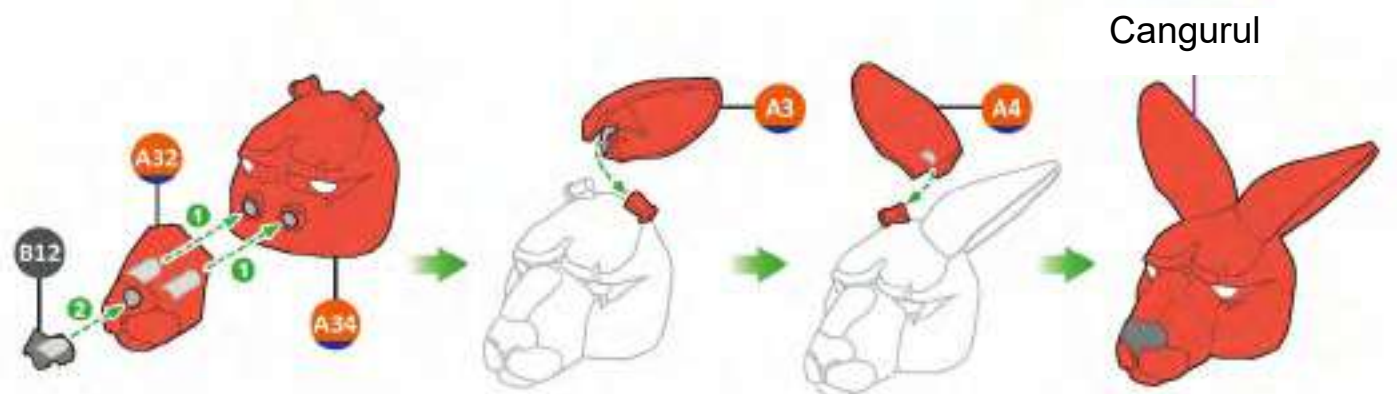
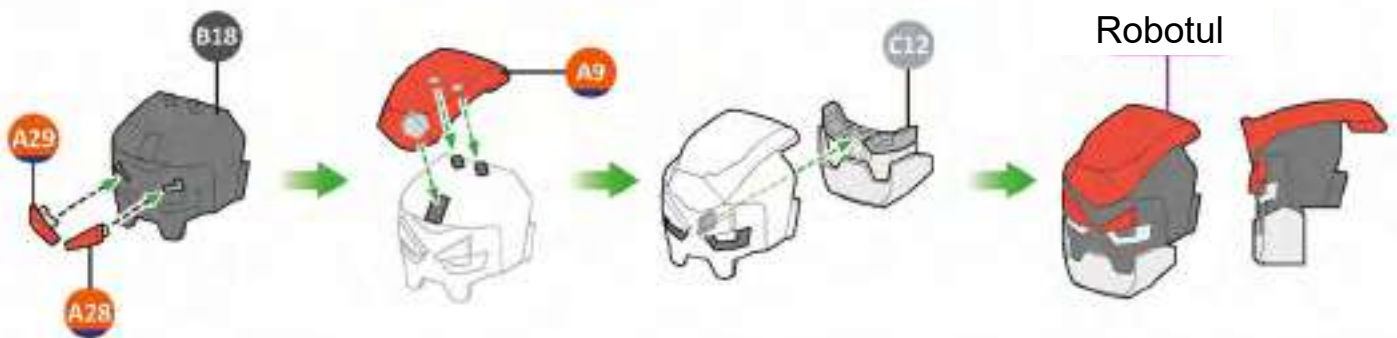



CORPUL

1

Invertiti pentru a strange

Invertiti pentru a strange

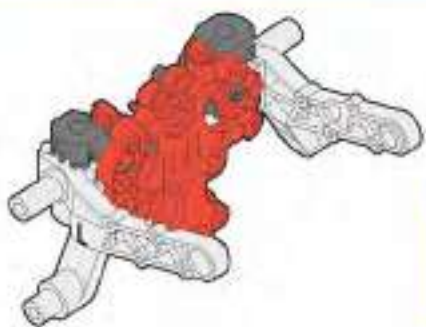
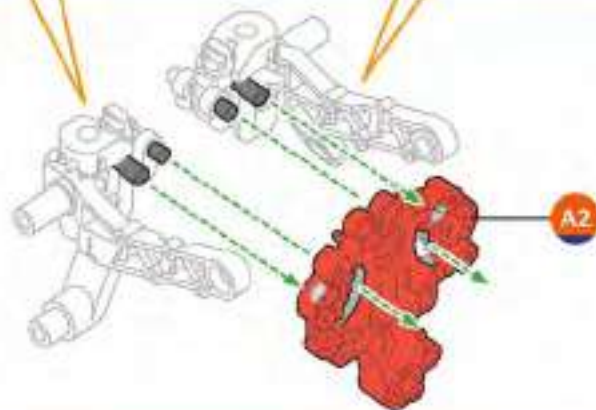
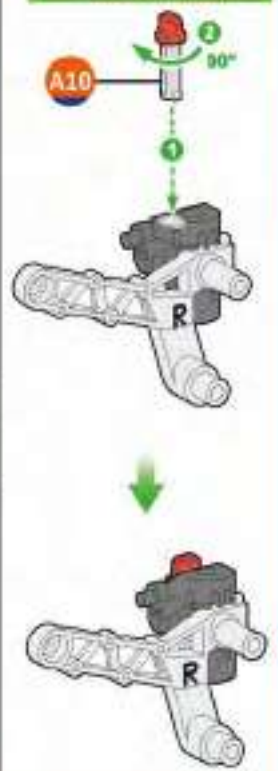
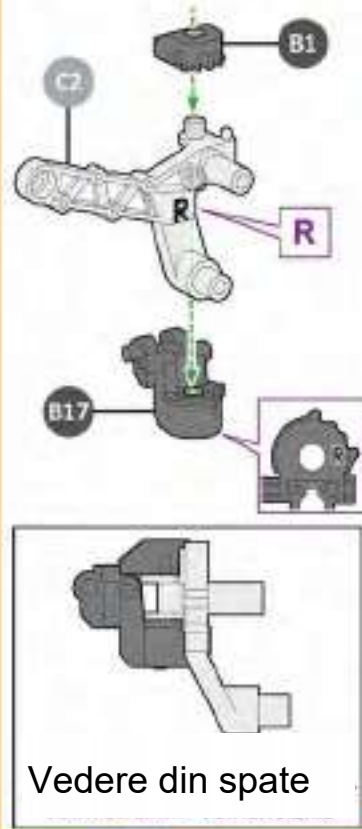
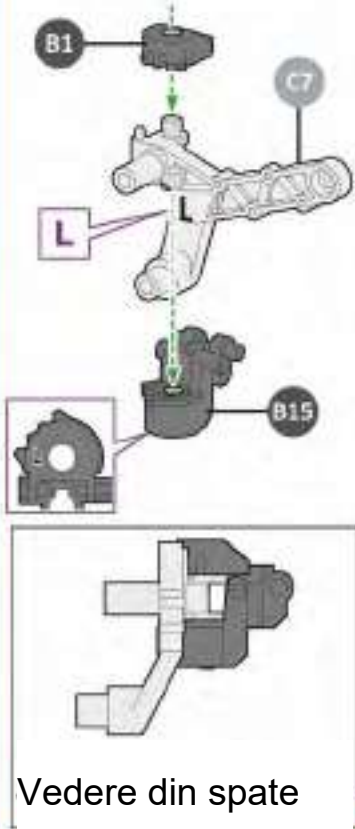

Rotiti



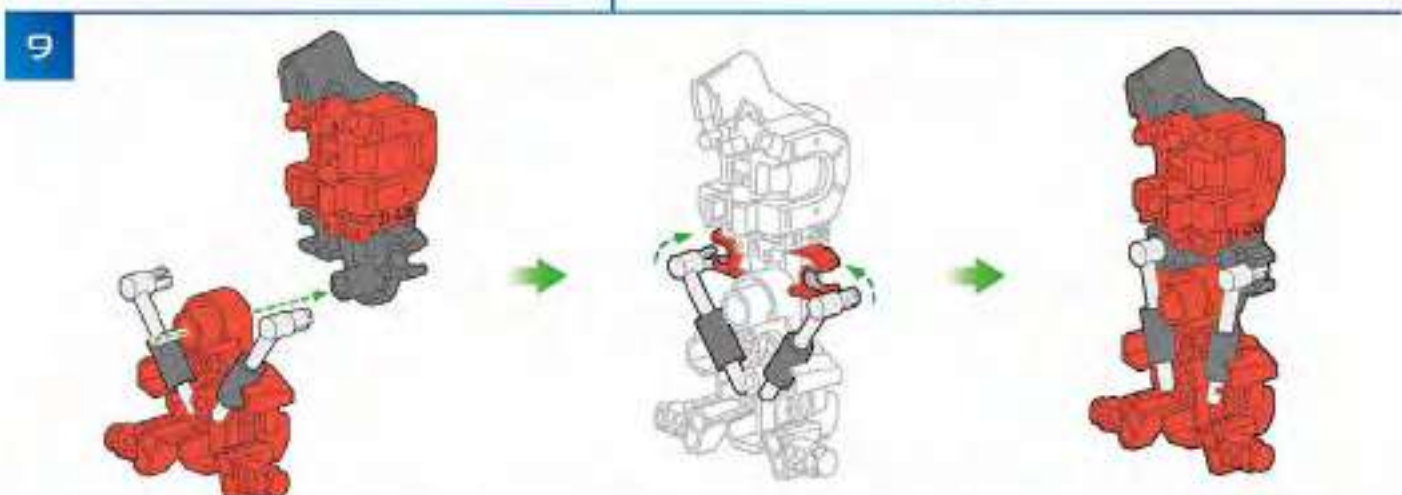
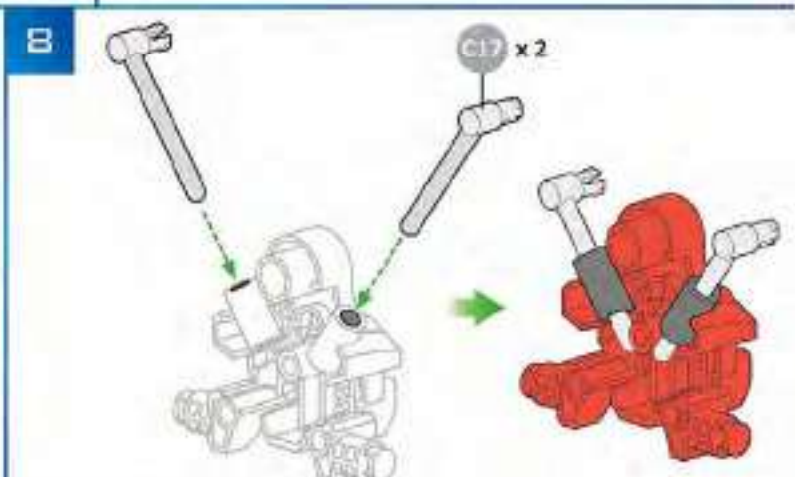
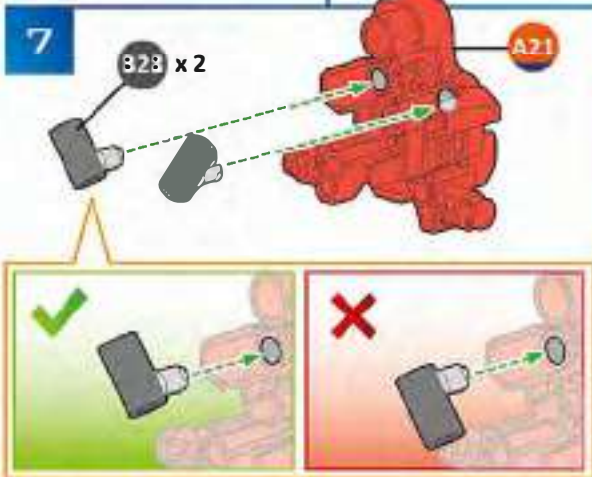
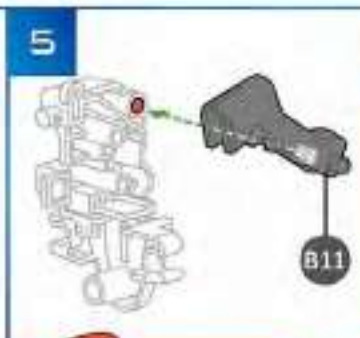
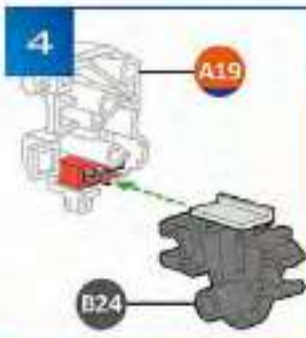
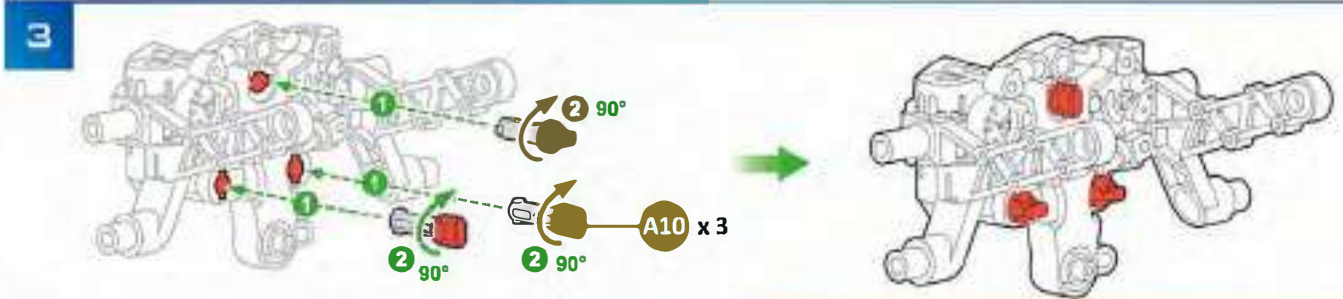

10

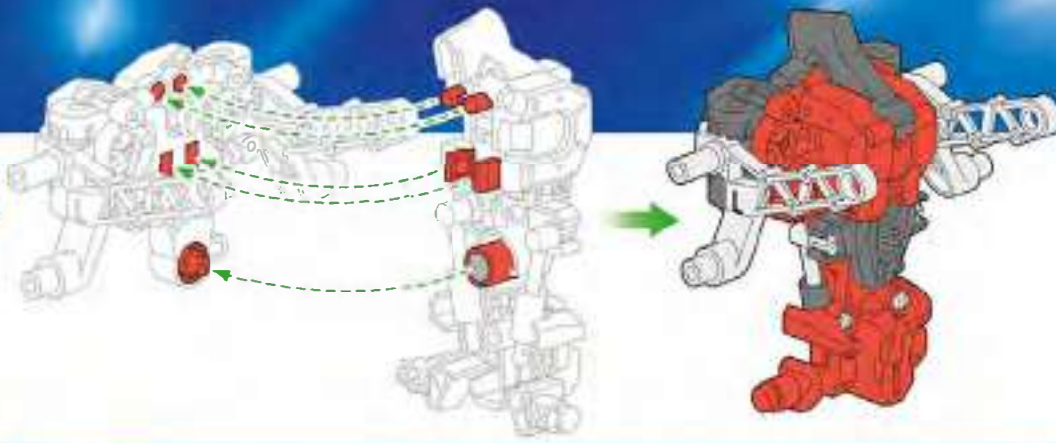

11

B26 A14 x 2

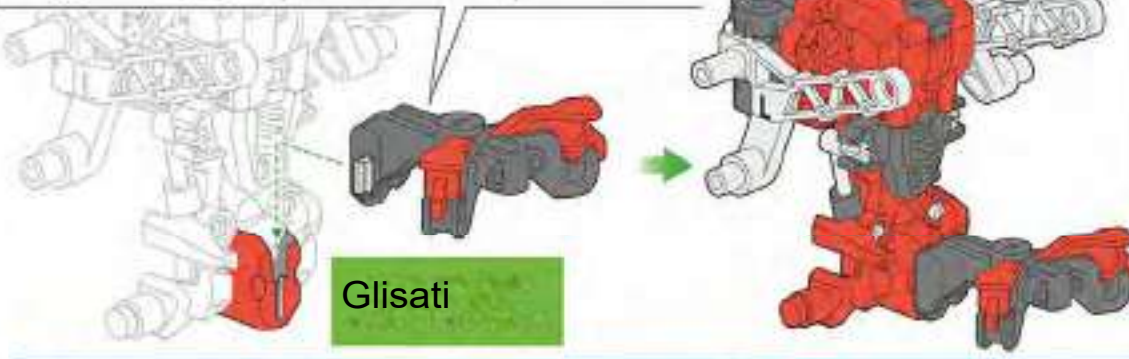

12

C20

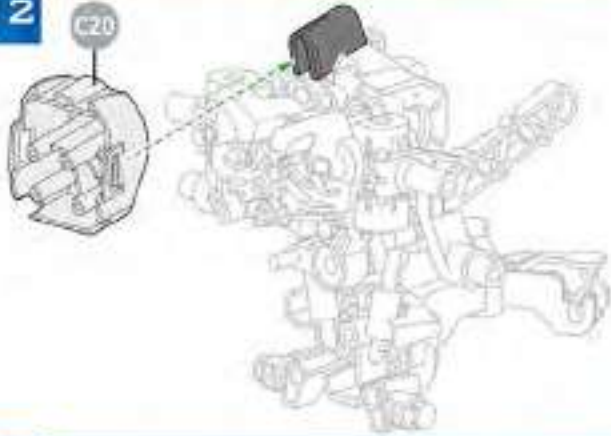

13

C18

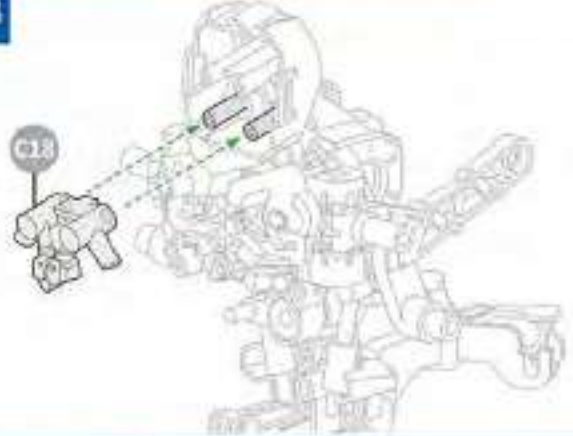

14

C C21

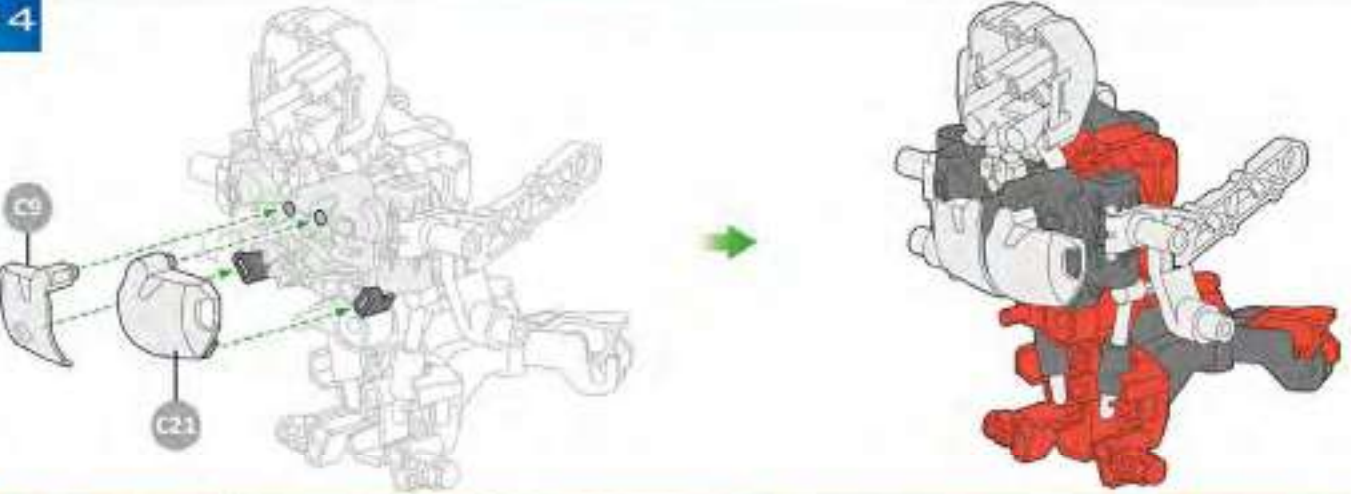

BRATUL DREPT

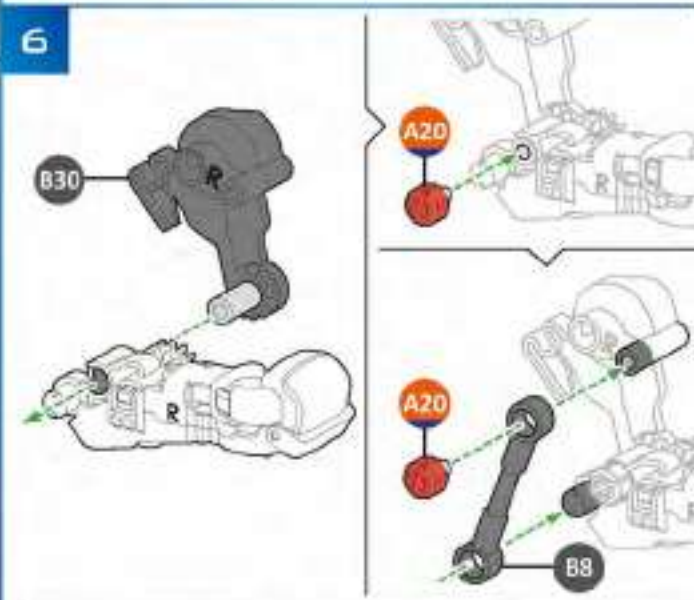
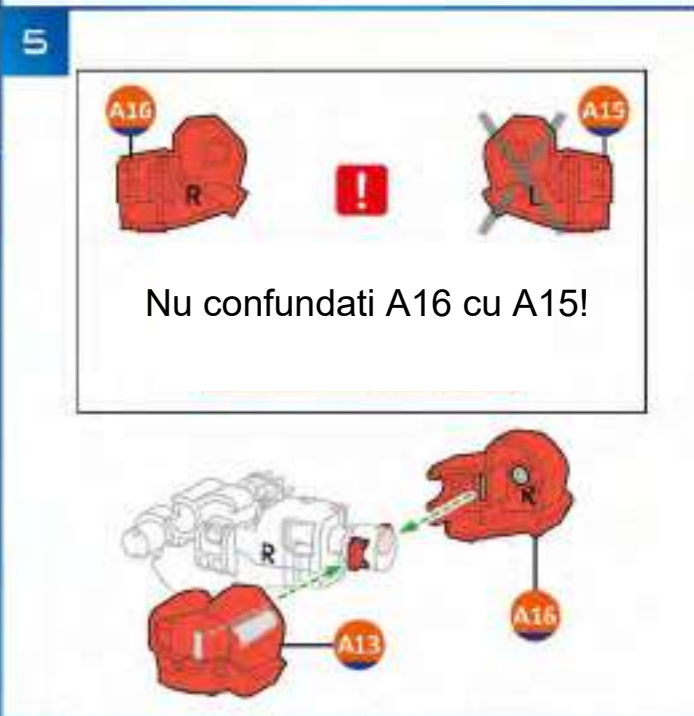
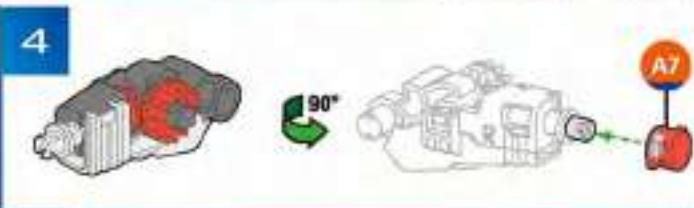
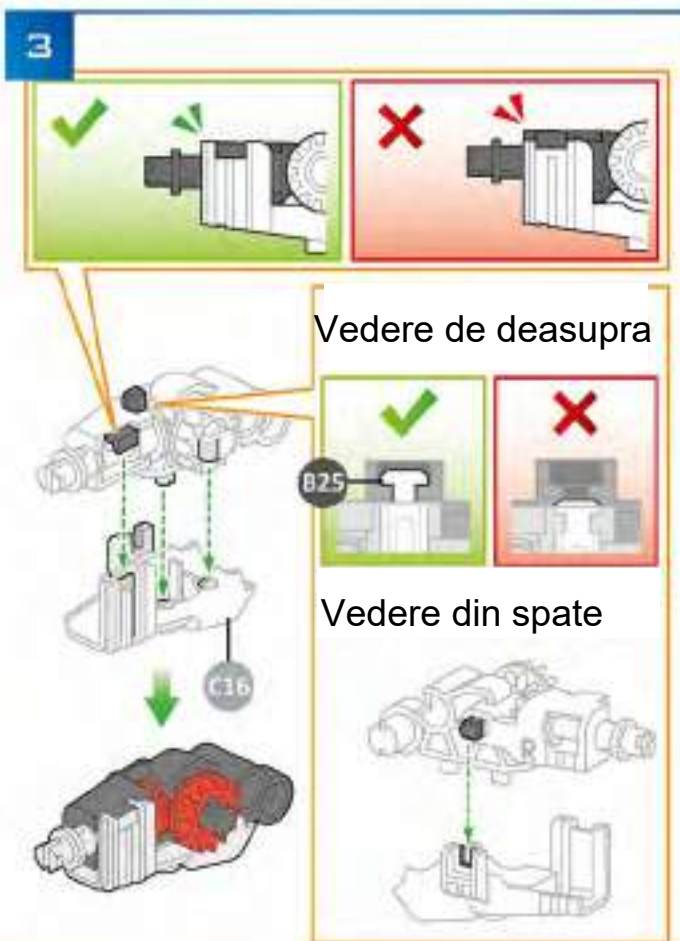
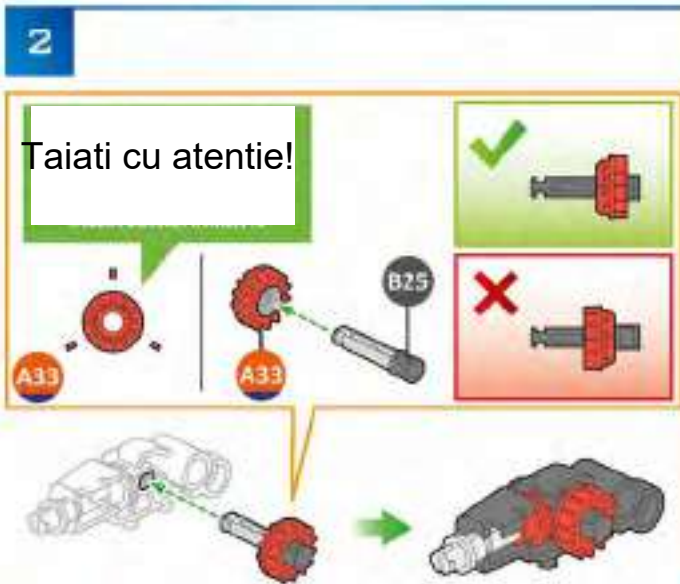
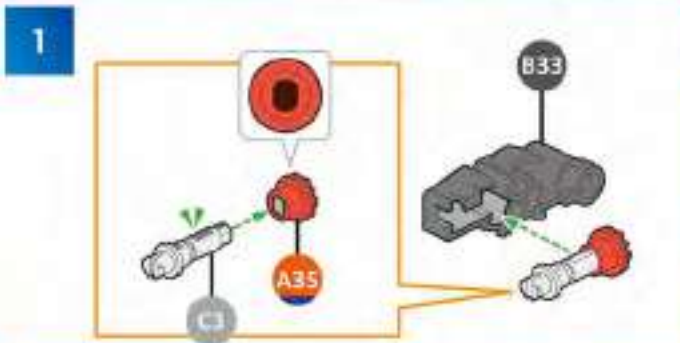

BRATUL STANG

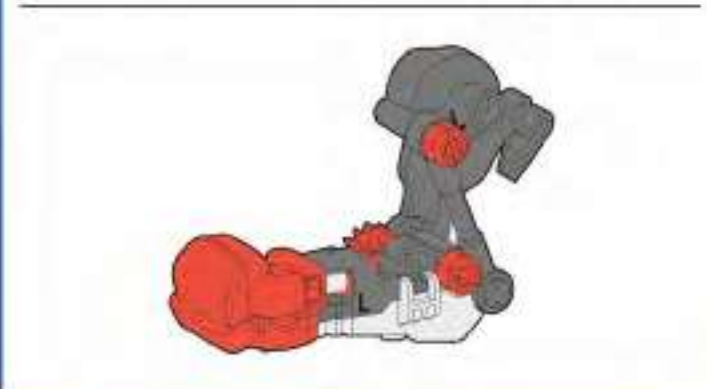
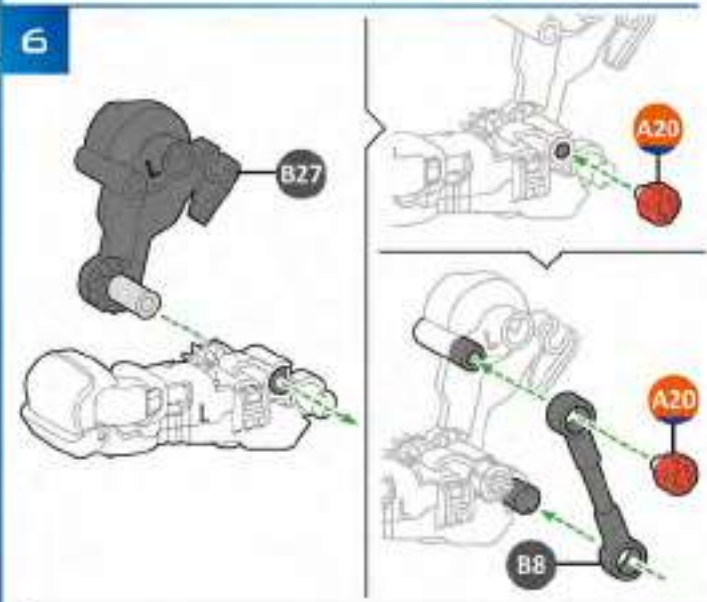
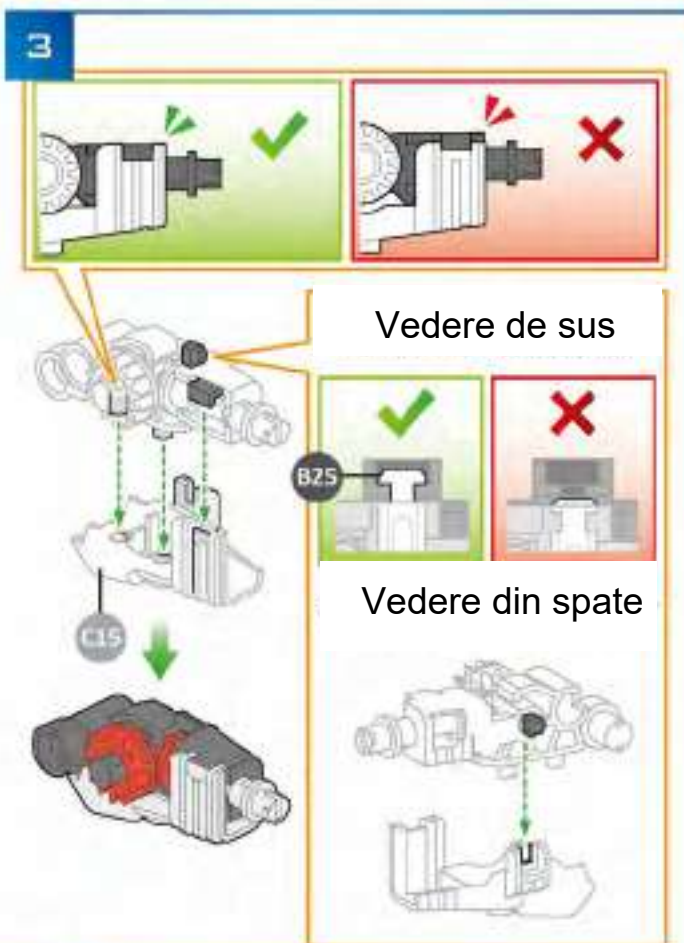
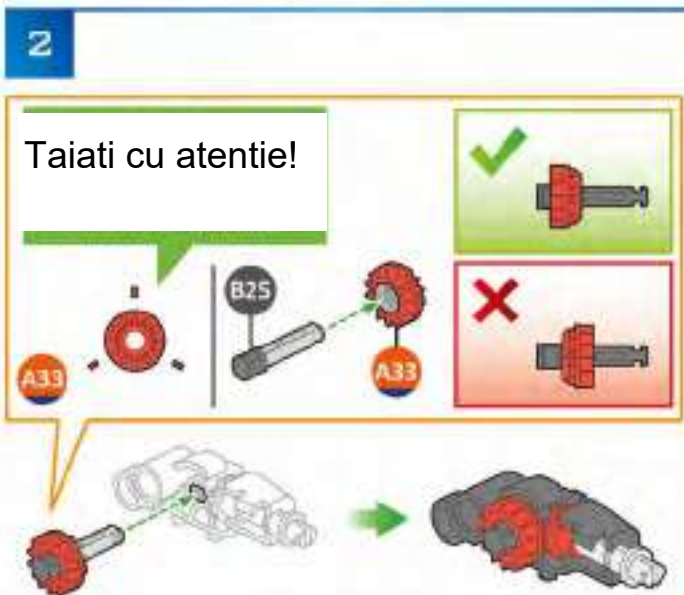
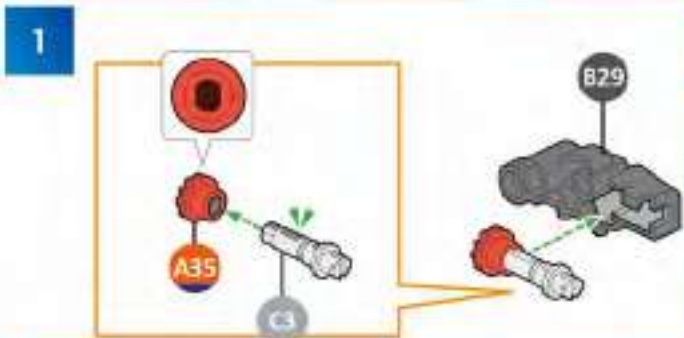

PICIORUL DREPT

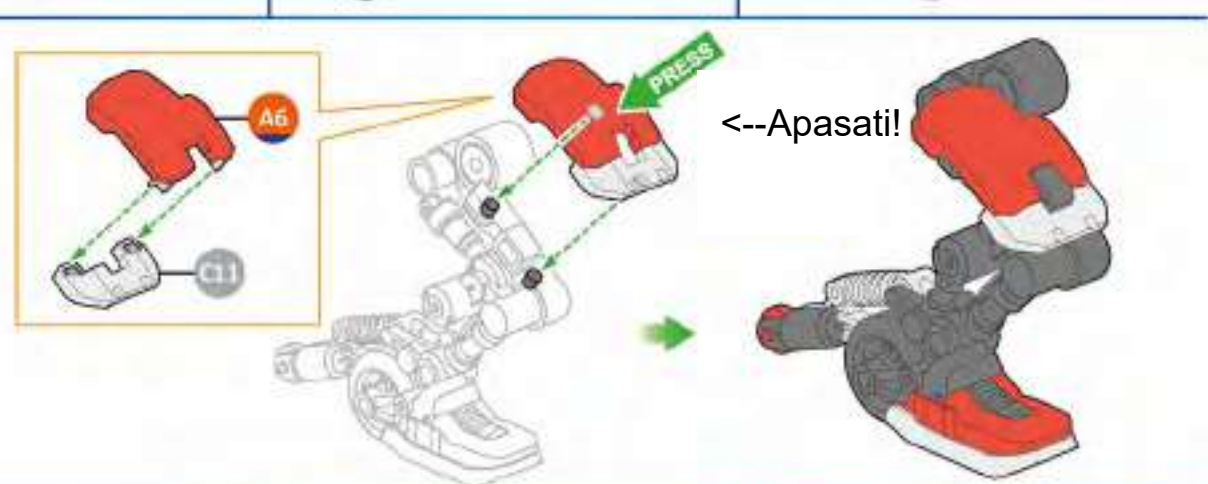
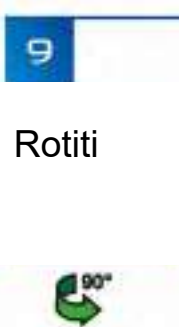
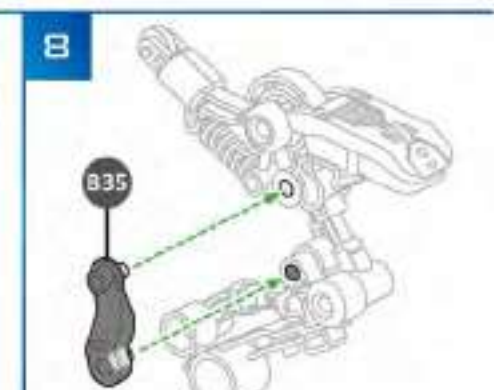
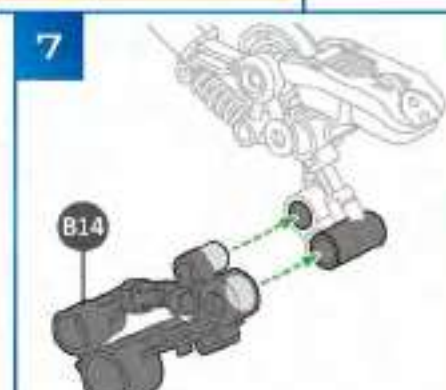
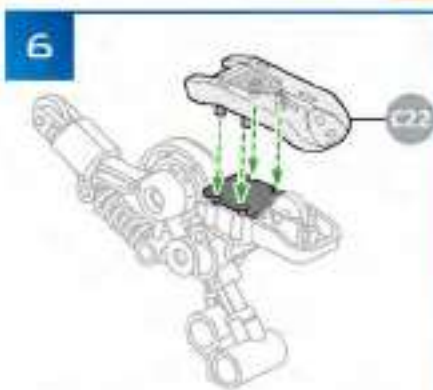
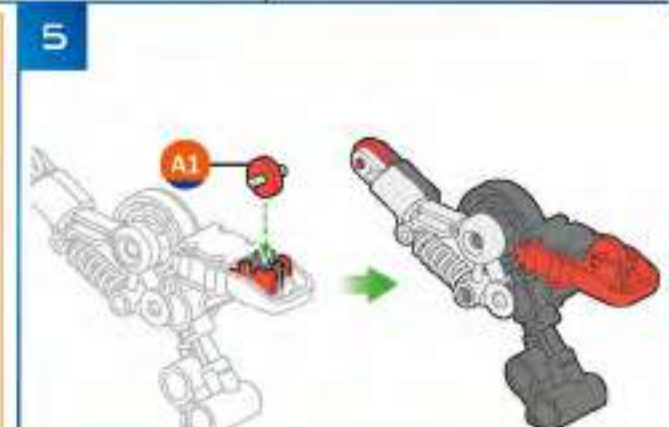
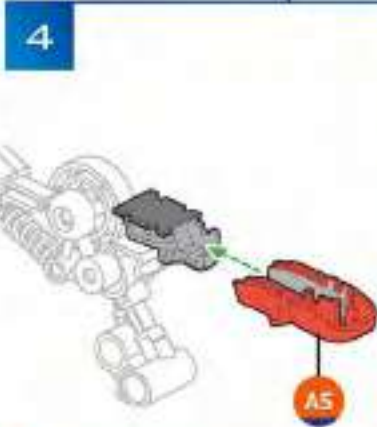
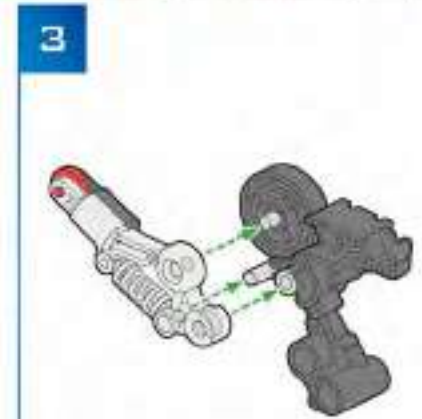
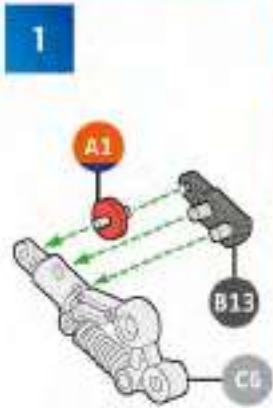



PICIORUL STANG

1

2

Taiati cu atentie

3

4

Aliniati gaurile

5

6

7

8

9

Rotiti

90°

Apasati -->

MANETA

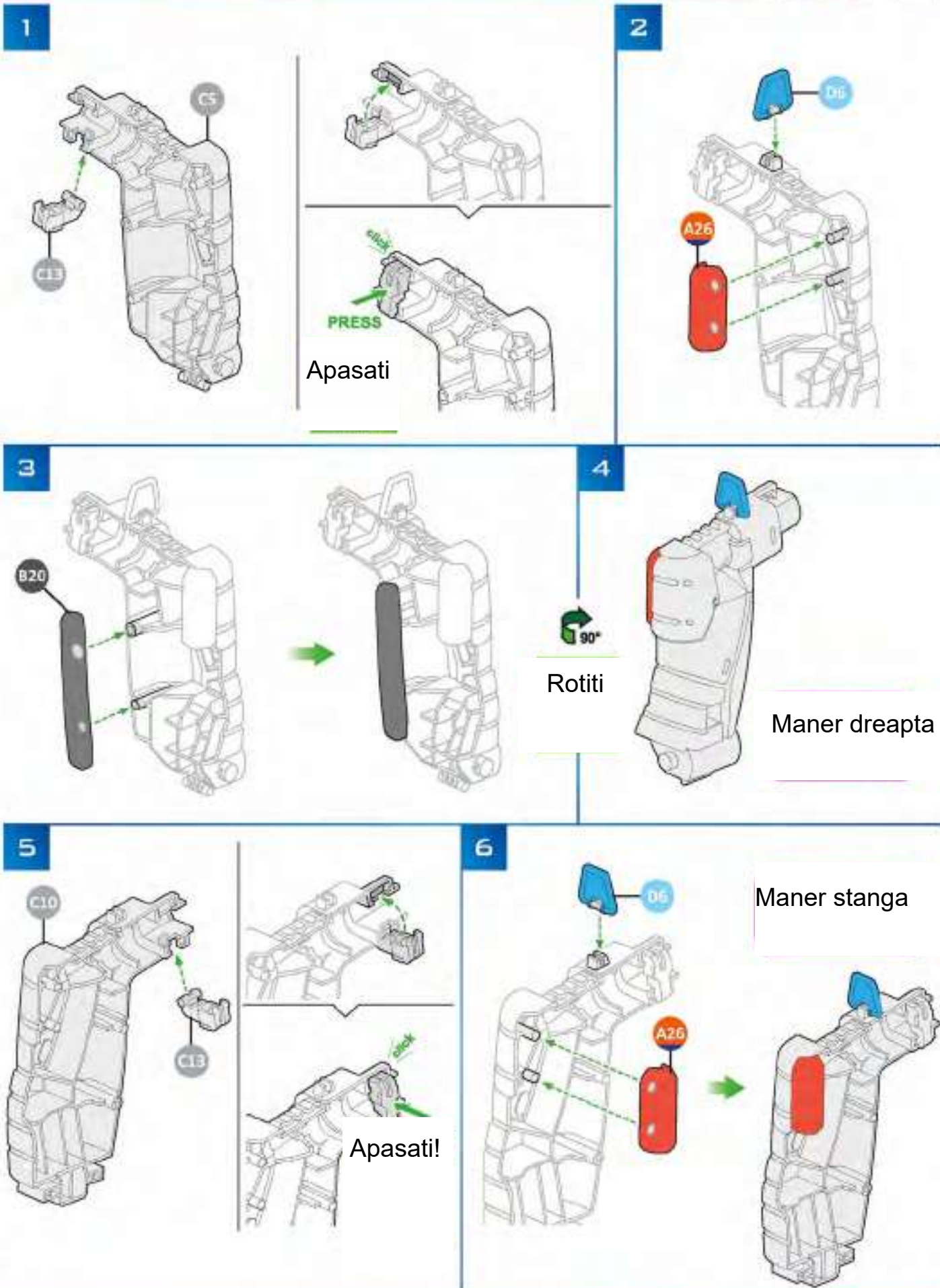

7

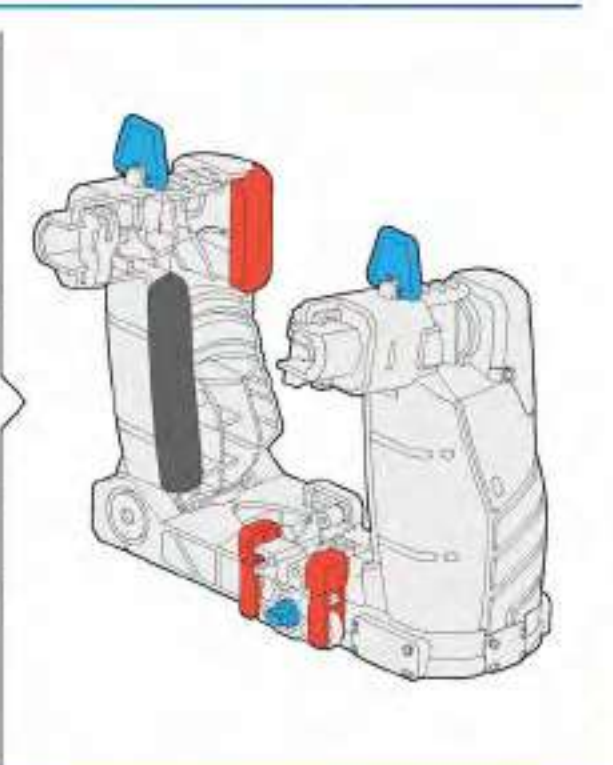
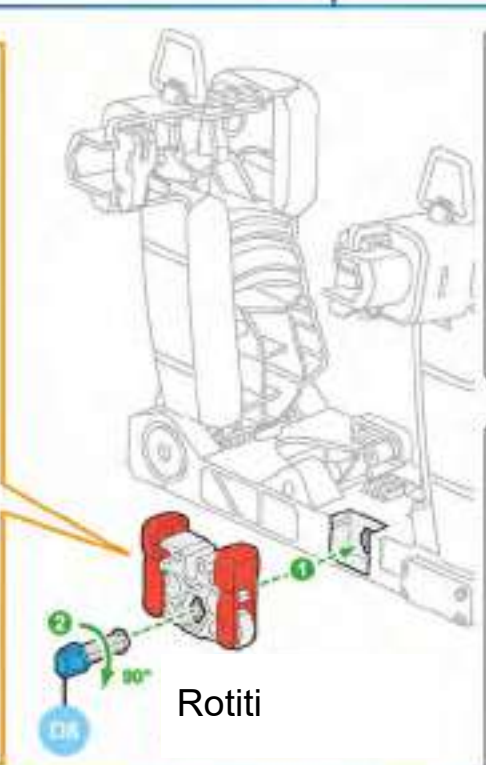
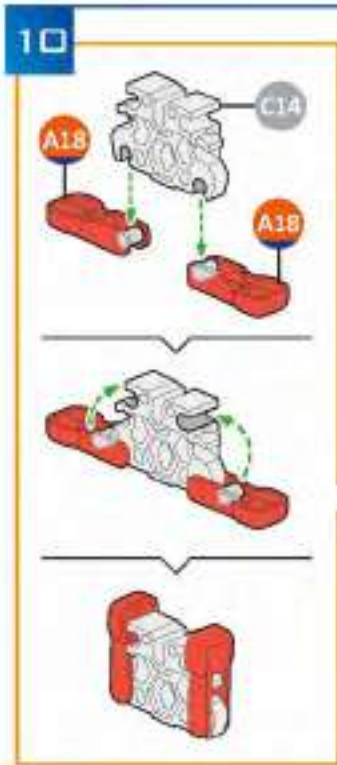
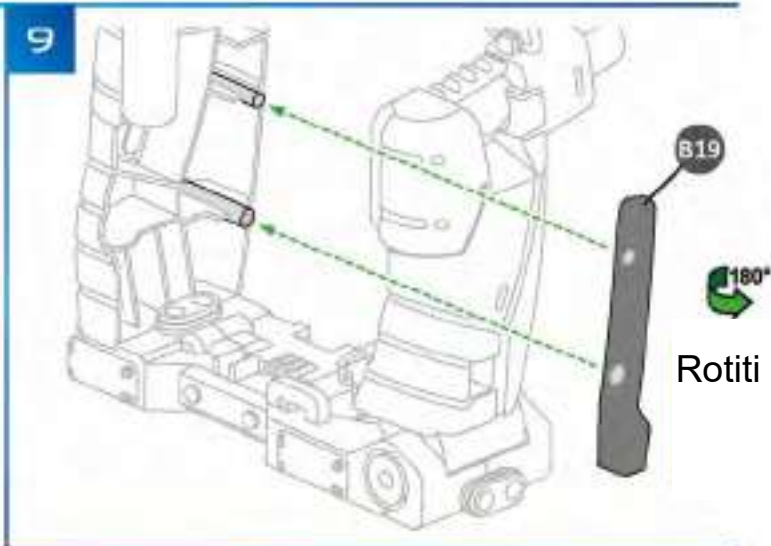
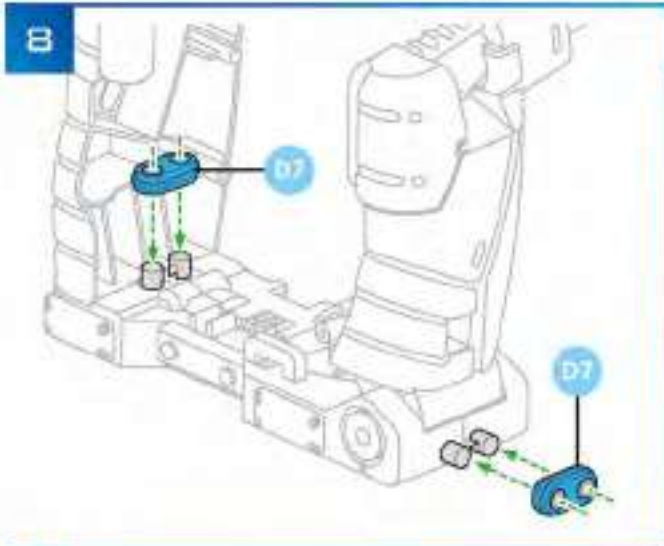
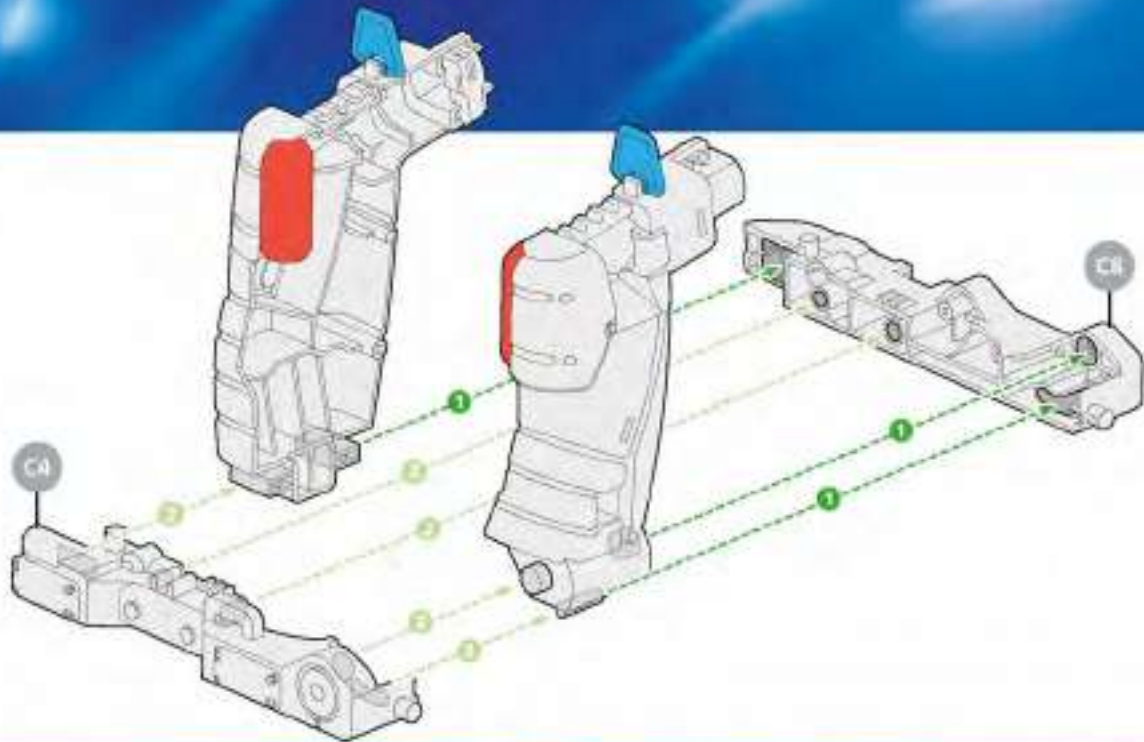

SISTEMUL HIDRAULIC



Marcati tuburile

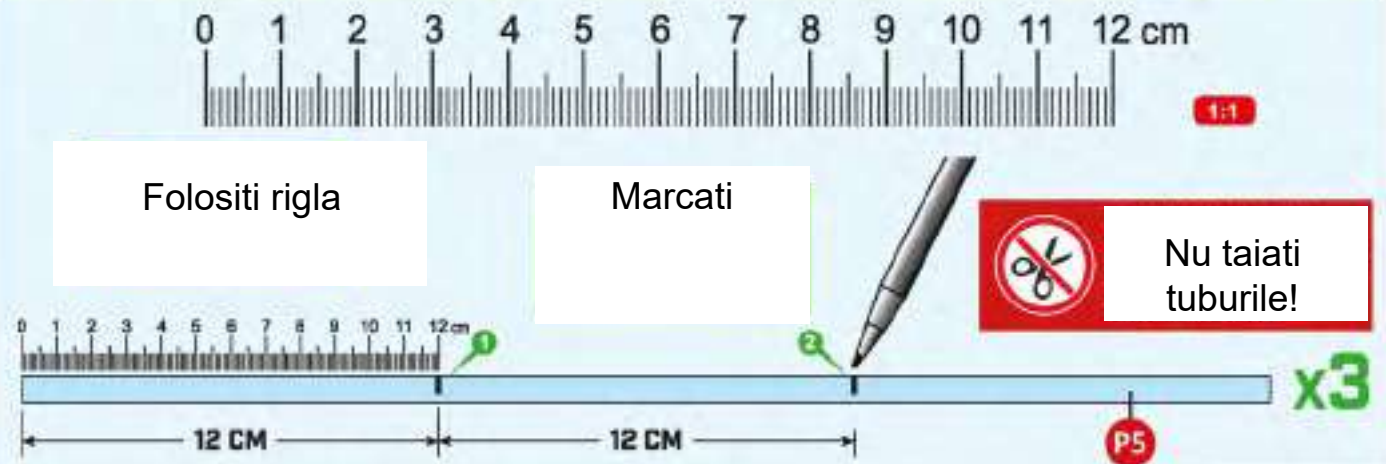

Largirea tuburilor



Aplicarea uleiului

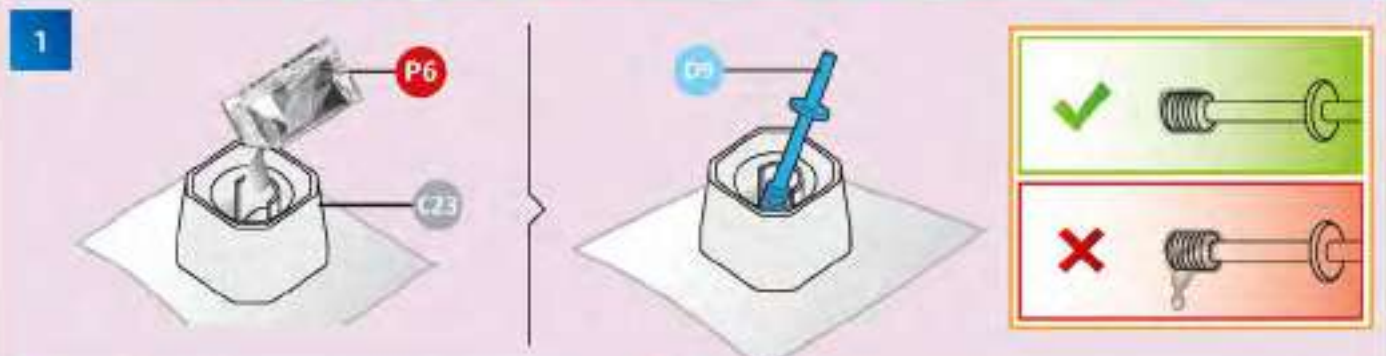

Uleiul ajuta piesele sa se miste corespunzator.



D 1

CILINDRUL D1



1



2

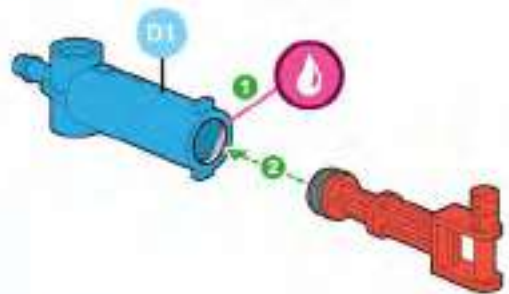

3

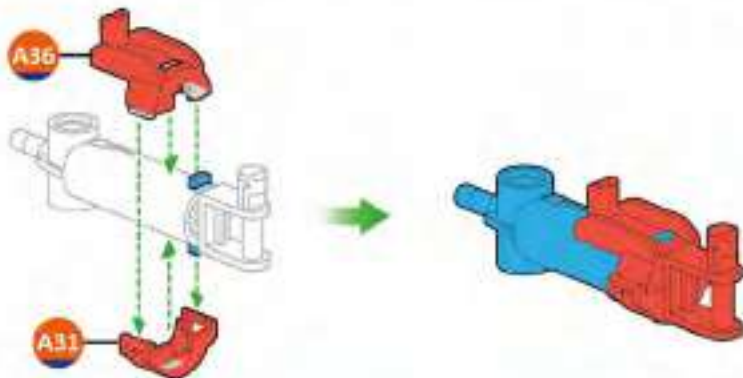

4

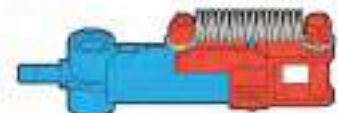
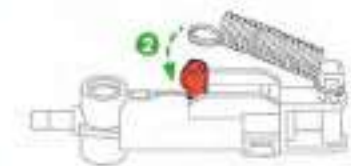
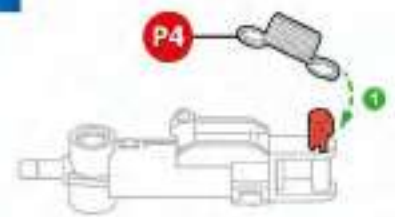

5

Atentie la sensul de montaj

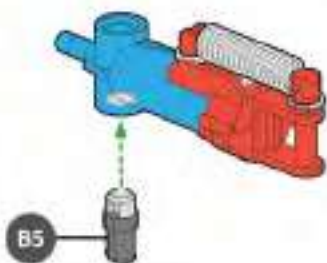

Cilindrul **D1**



D2 & D3 CILINDRII D2&D3

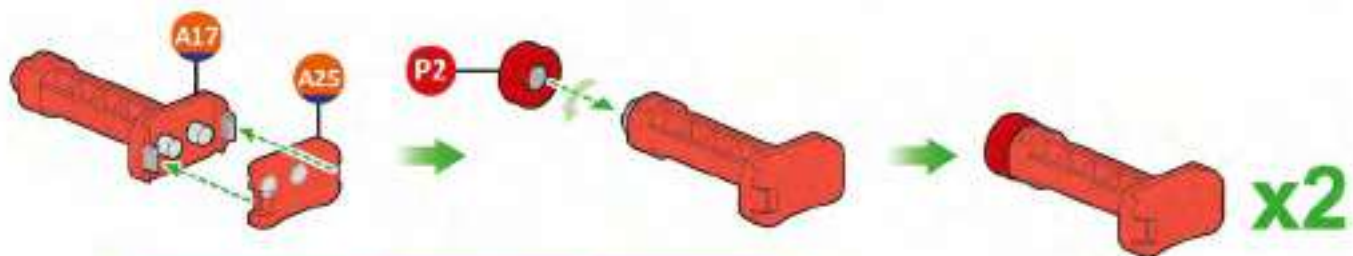

D2

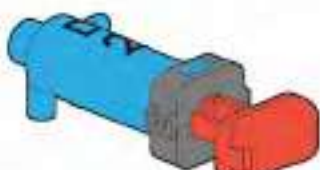
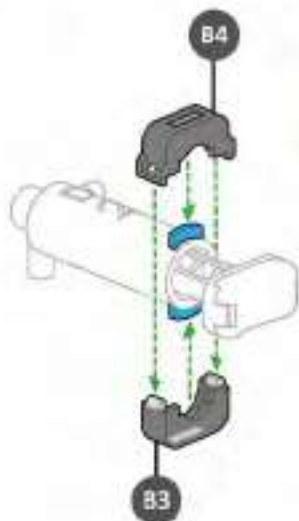
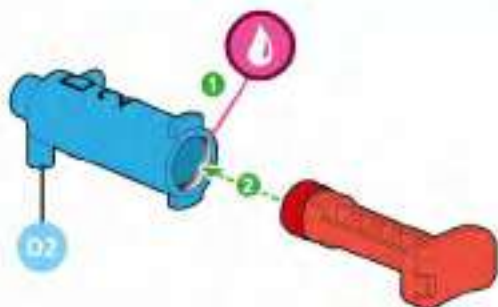

Cilindrul **D2**

D3

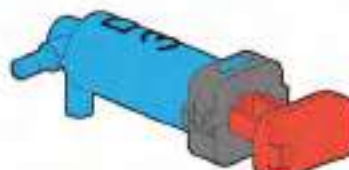
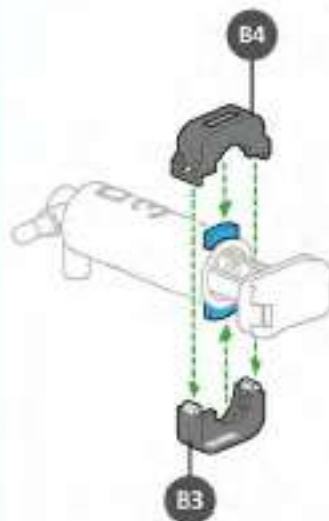
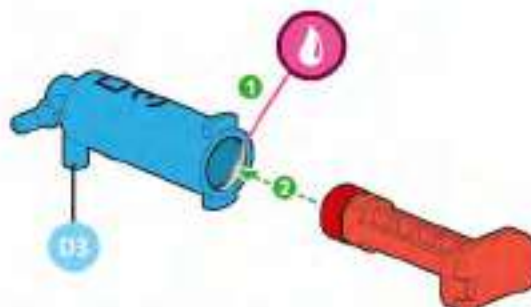

Cilindrul **D3**

D4 & D5

CILINDRII D4&D5



D4

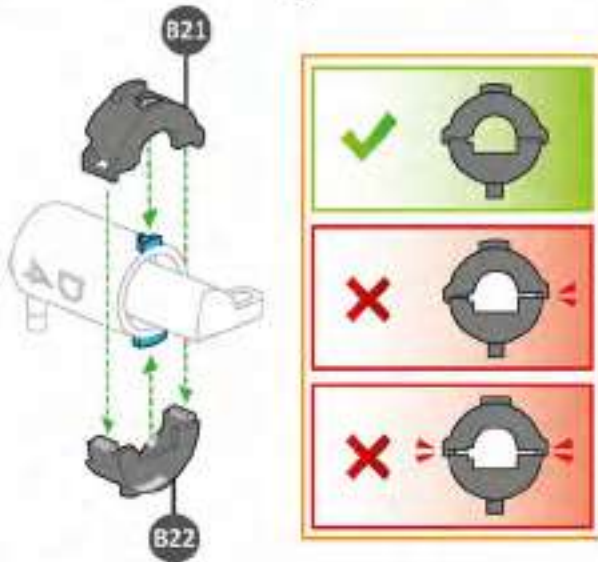
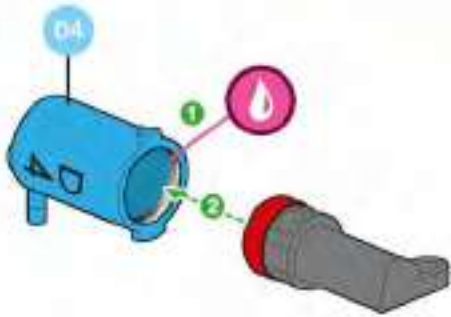

Cilindrul **D4**

D5

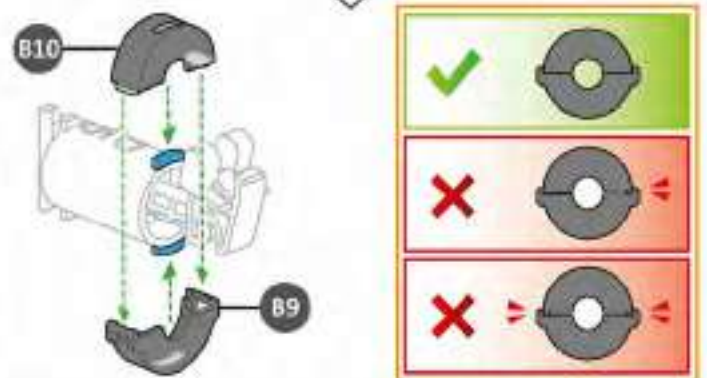
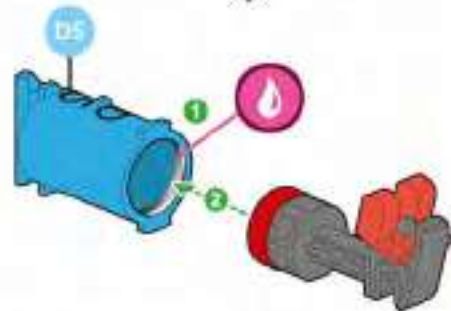
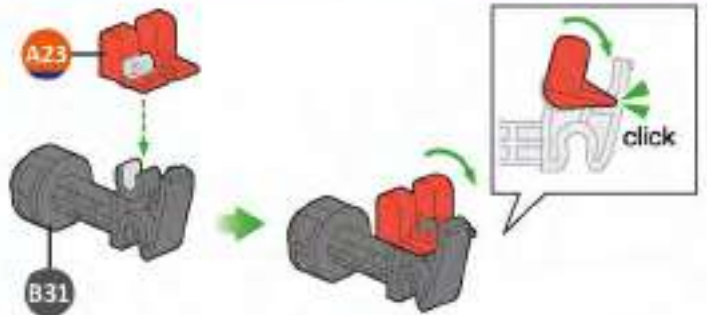

Cilindrul **D5**

D4 & D5

ASAMBLARE D4&D5

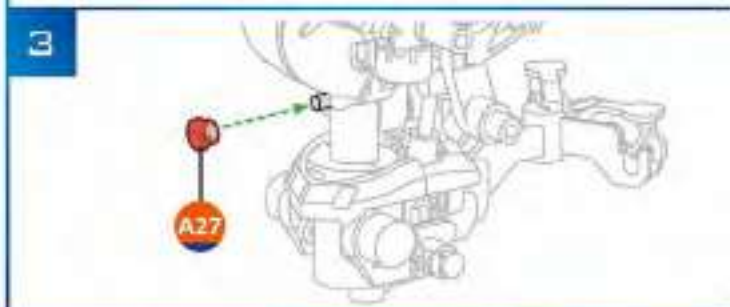
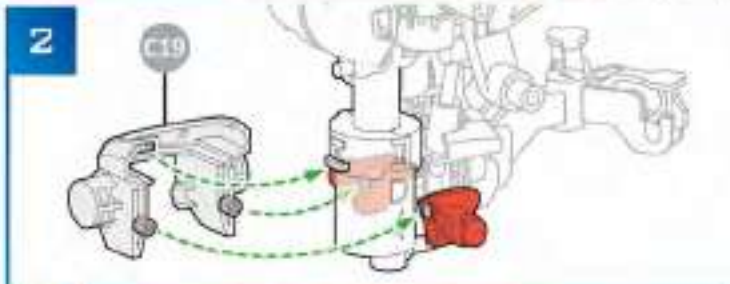
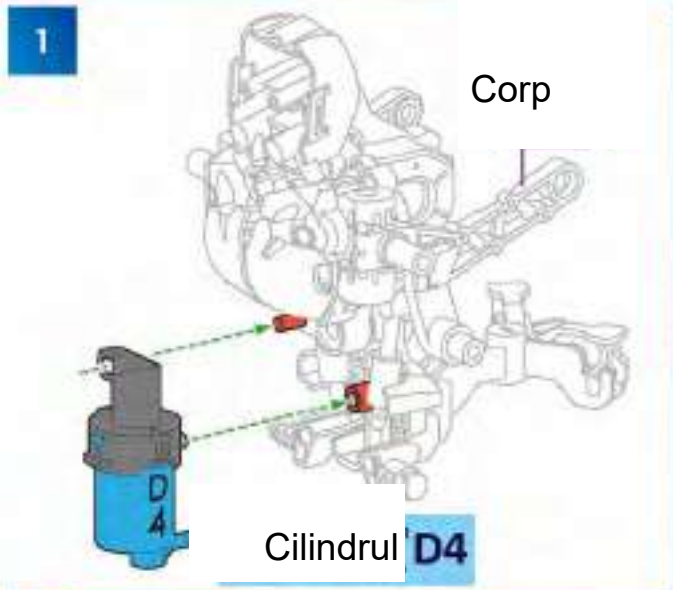

1 Ridicati pistonul pana sus



2 Apasati pistonul pana jos



3 Repetati pasii 1 si 2 pentru a umple cilindrul.



6

Largiti

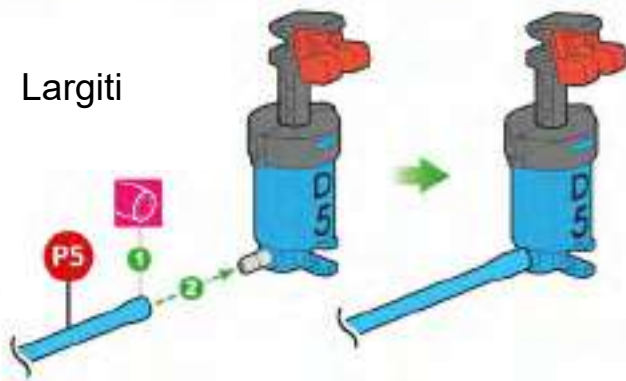

7

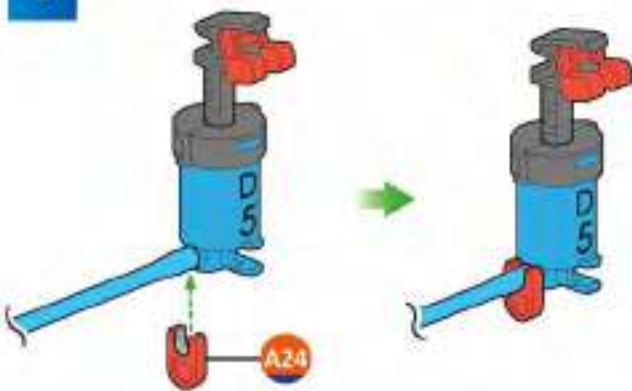

10

Apasati

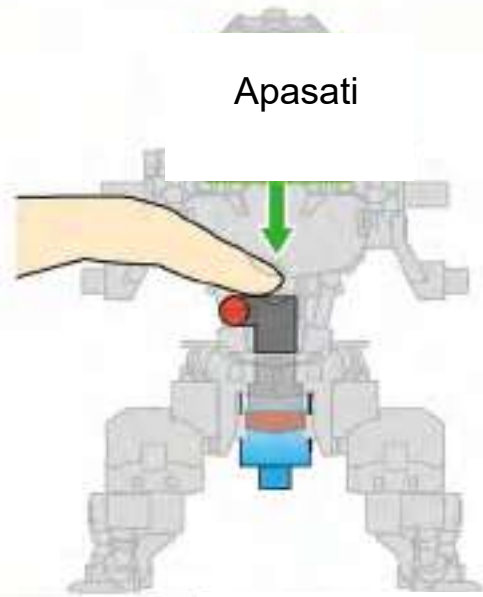

8

Largiti

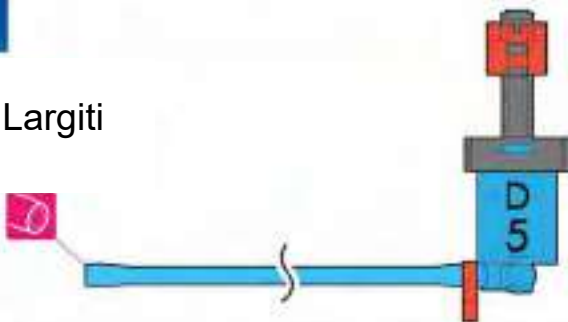

Boxerul se inclina intr-o parte

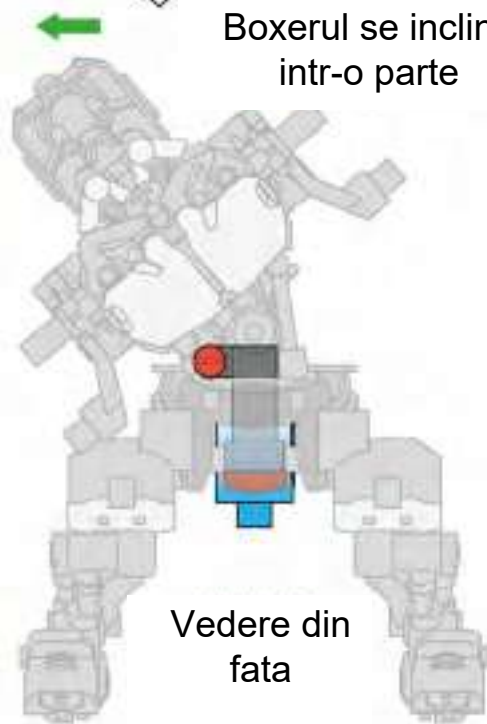

9

Reumpleti cilindrul

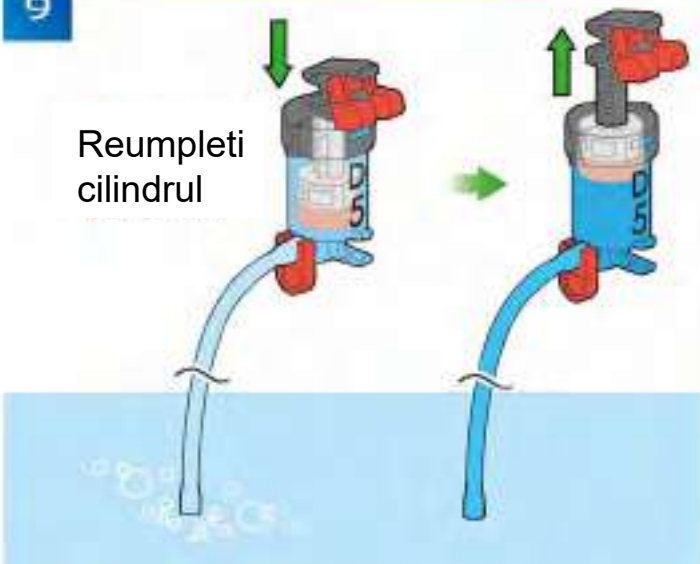

Vedere din fata

11

Mentineti cilindrul D4 apasat pentru acest pas.

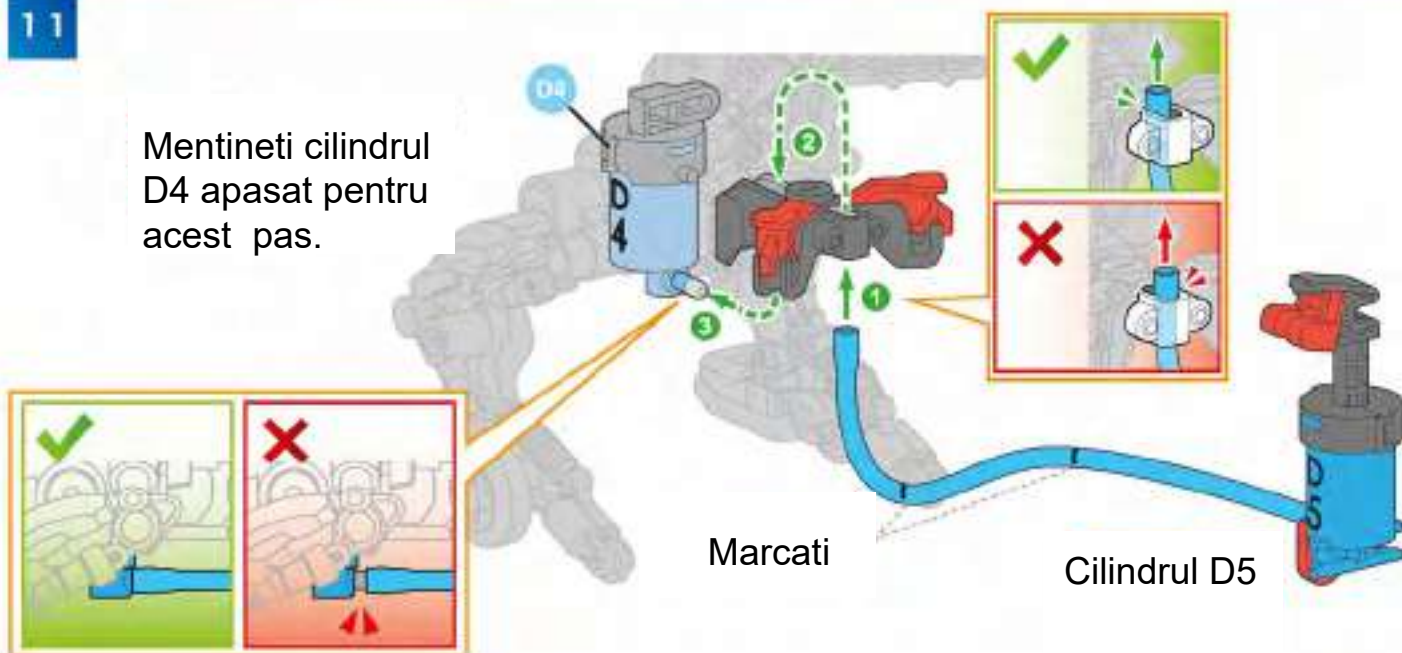

12

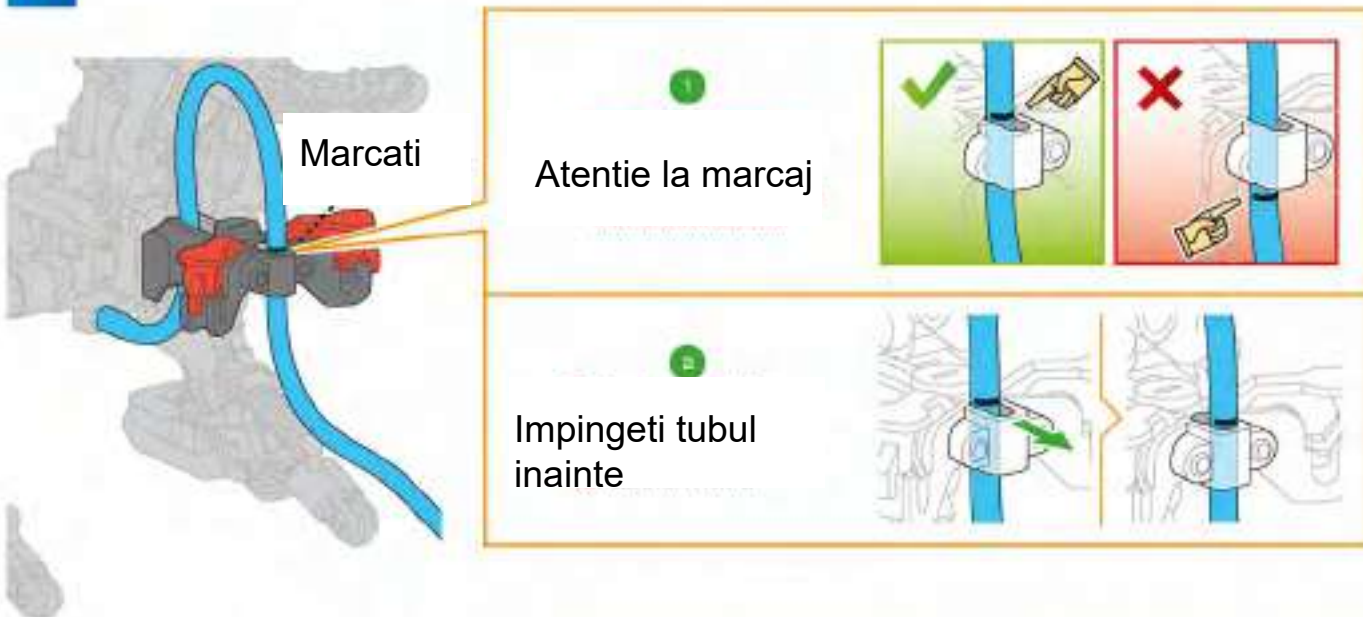

13

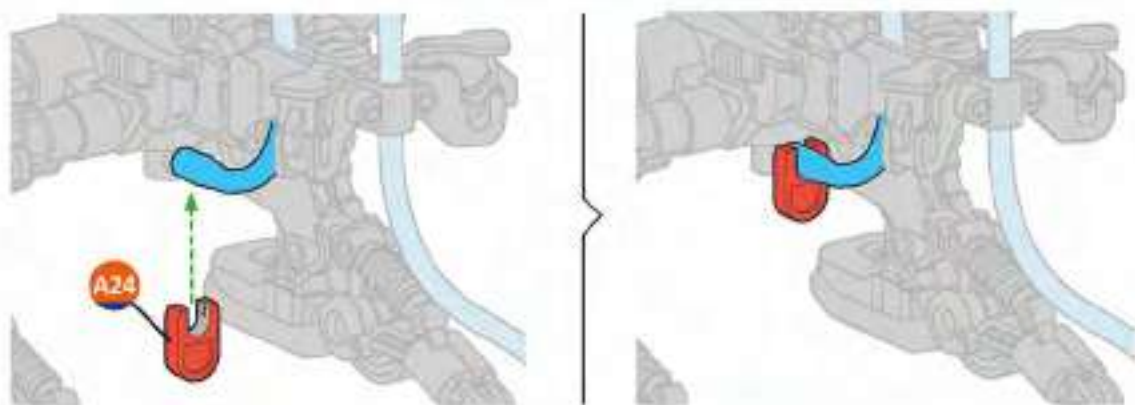

14

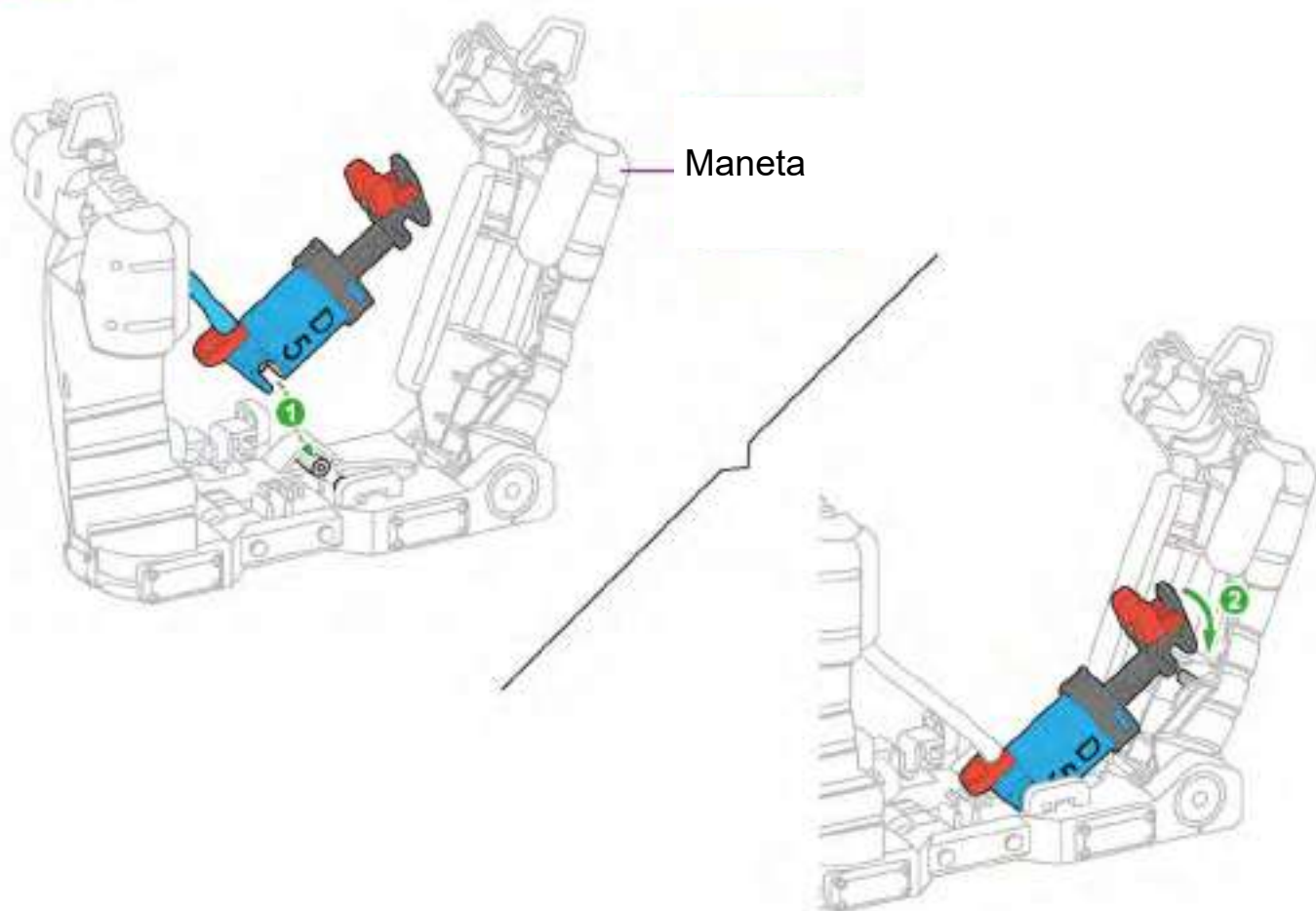

15

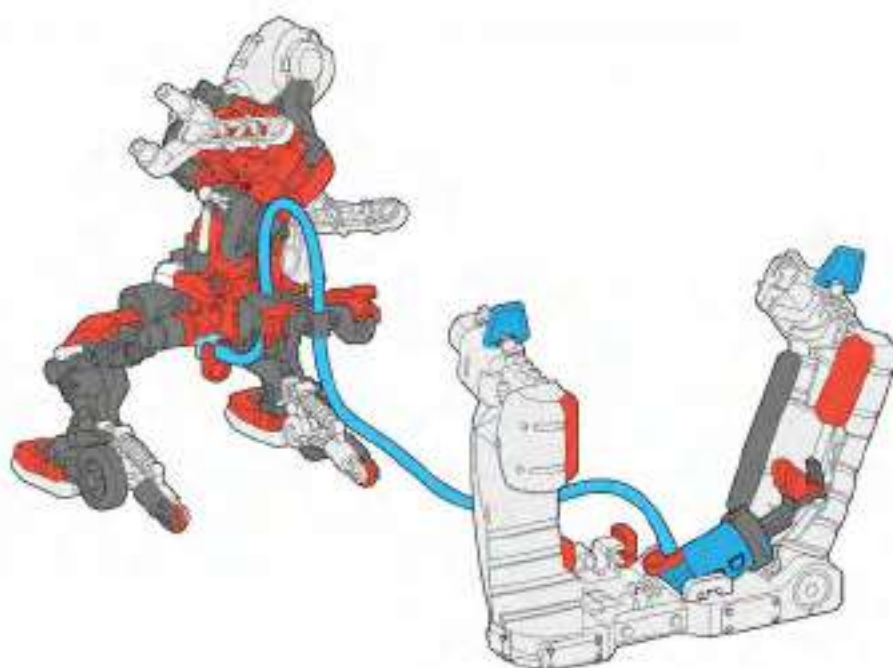

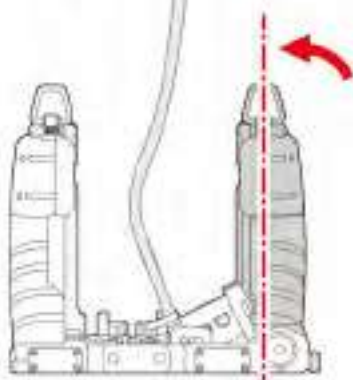
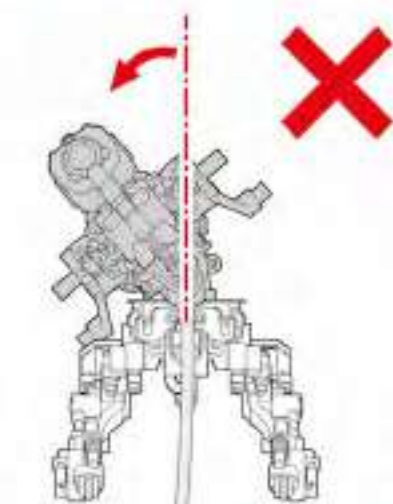
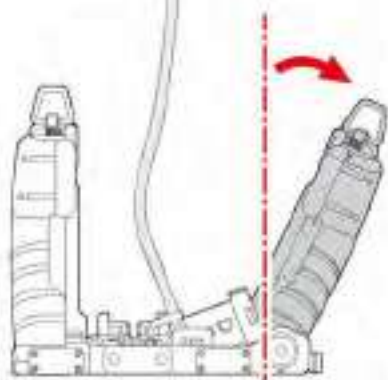
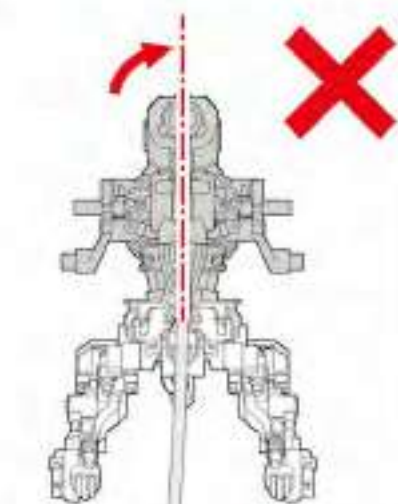
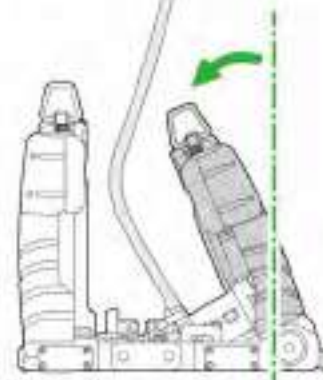
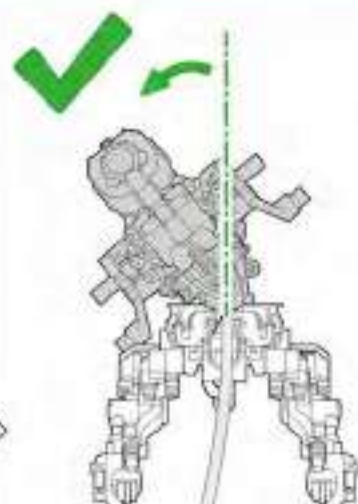
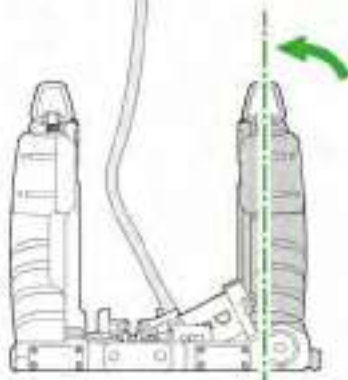
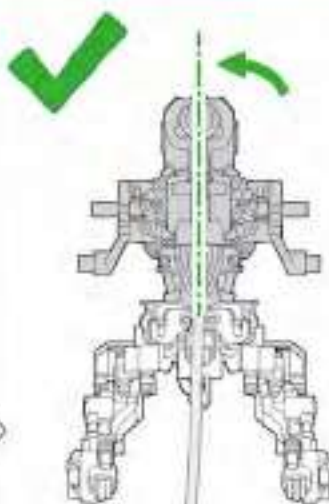
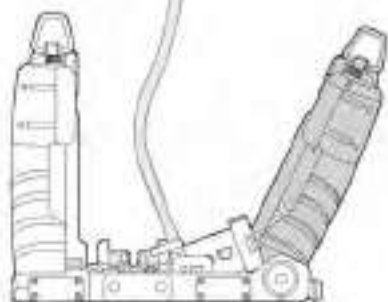
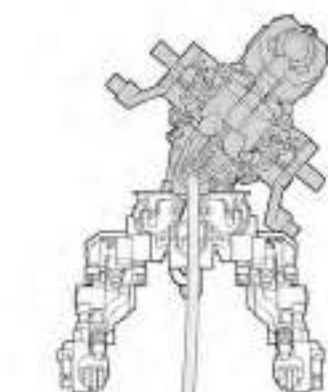

Probleme? Reveniti la pasul 10 si asigurati-va ca pistonul este apasat complet pana jos.



D1 & D2

ASAMBLARE D1&D2

1 Cilindrul **D2**

Ridicati pistonul pana sus

Apasati pistonul pana jos

Repetati pasii 1 si 2 pentru a umple cilindrul.

2 Largiti

3

4 Largiti

5 Reumpleti cilindrul

6 Cilindrul **D1**

7

The assembly guide consists of seven numbered steps:

- Step 1:** A blue cylinder labeled 'D2' is shown partially submerged in a beaker of water.
- Step 2:** The red piston is pulled upwards, indicated by a green arrow and the text 'Ridicati pistonul pana sus'.
- Step 3:** The red piston is pushed downwards, indicated by a green arrow and the text 'Apasati pistonul pana jos'.
- Step 4:** The piston is pulled up again, with the text 'Repetati pasii 1 si 2 pentru a umple cilindrul.' (Repeat steps 1 and 2 to fill the cylinder).
- Step 5:** The piston is pulled up, and the cylinder is shown filled with water. The text is 'Reumpleti cilindrul'.
- Step 6:** A blue cylinder labeled 'D1' is attached to the main assembly. A 'do/don't' inset shows the correct alignment (green checkmark) and incorrect alignment (red X).
- Step 7:** A red component labeled 'A24' is attached to the blue cylinder 'D1'. A 'do/don't' inset shows the correct alignment (green checkmark) and incorrect alignment (red X).

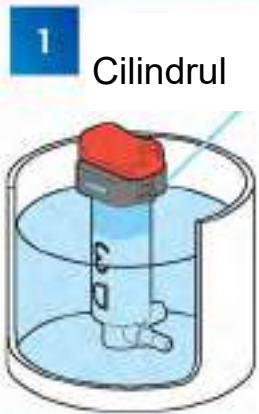

D3

Ridicati pistonul pana sus

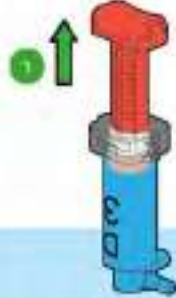

Apasati pistonul pana jos



Repetati pasii 1 si 2 pentru a umple cilindrul.

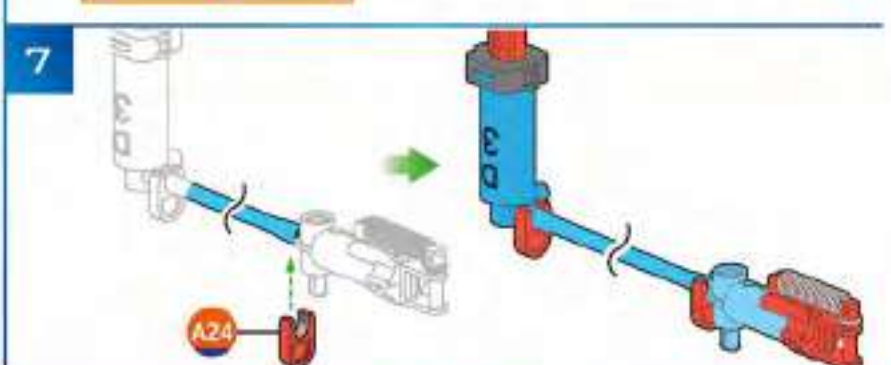
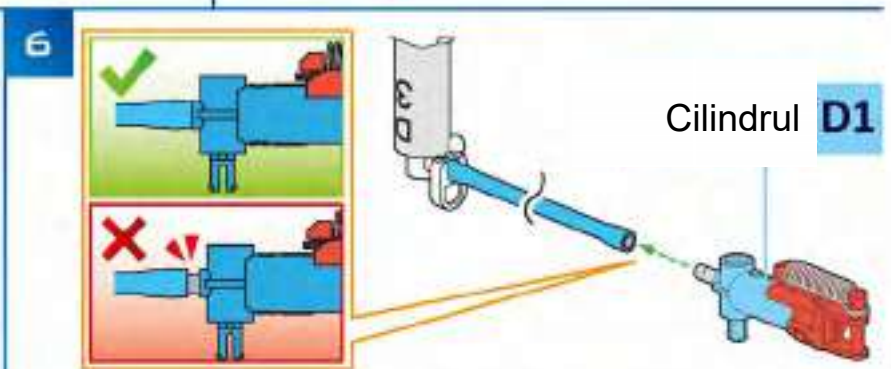
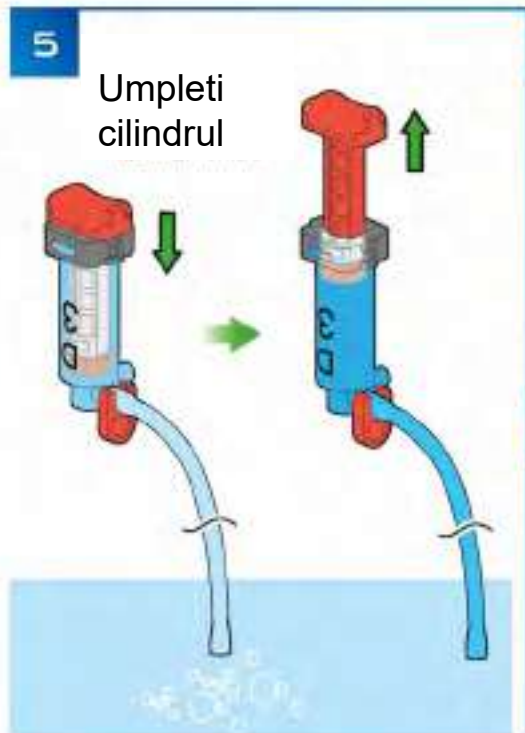
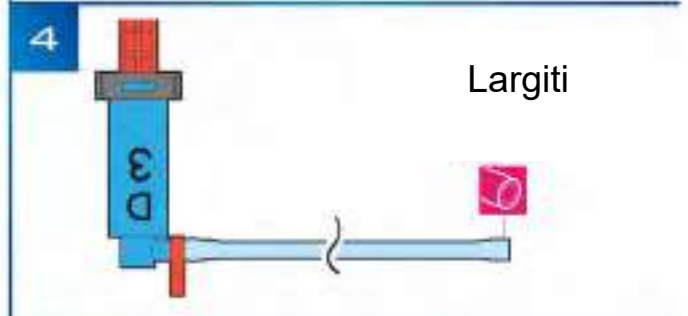
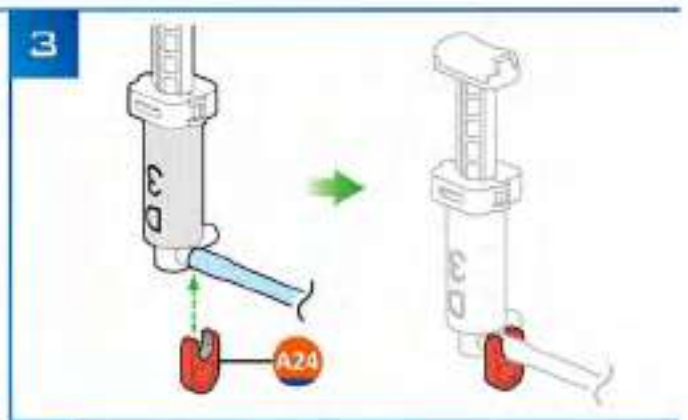
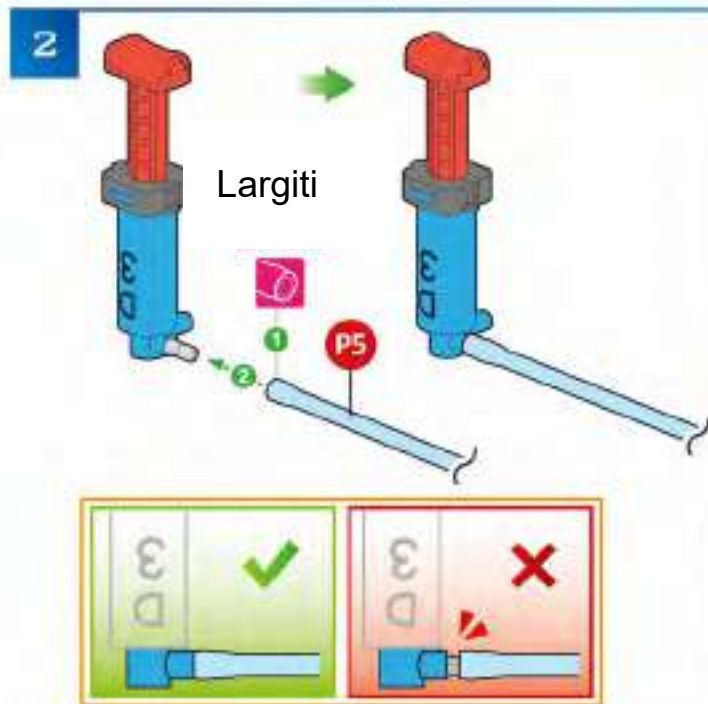
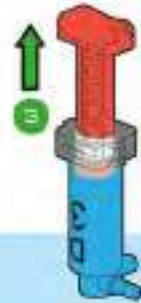

MONTAJ FINAL



1

Deschideti

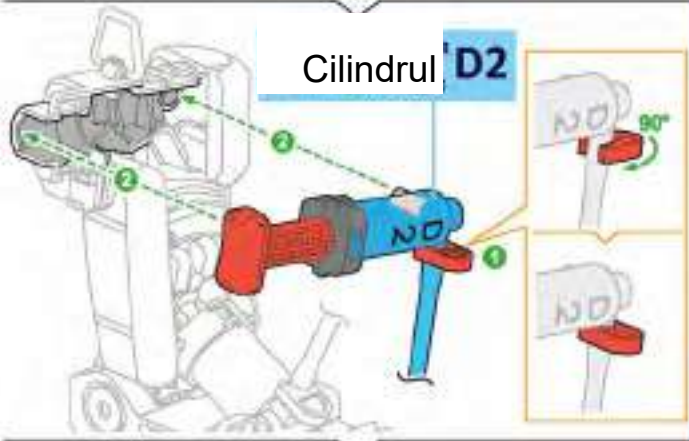

Cilindrul D2

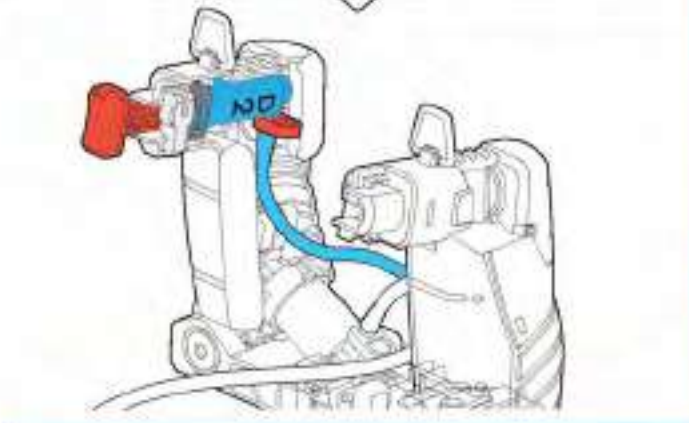
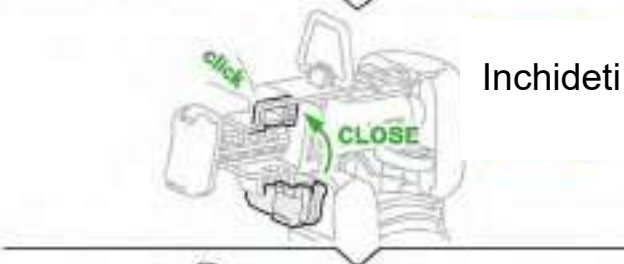

2

Cilindrul D1

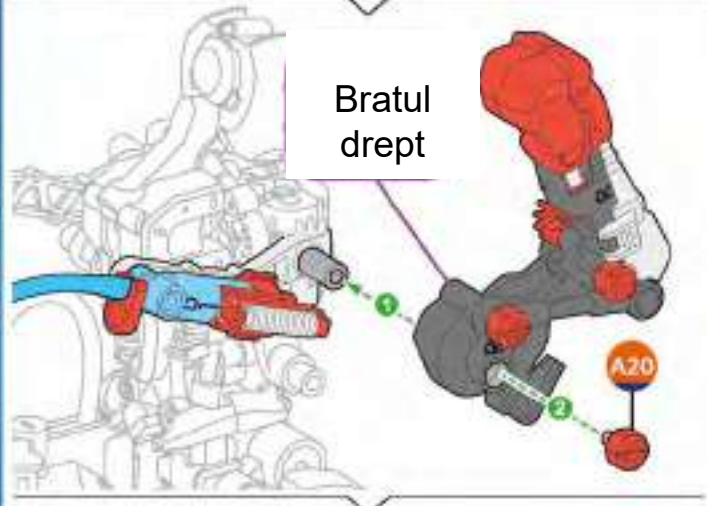
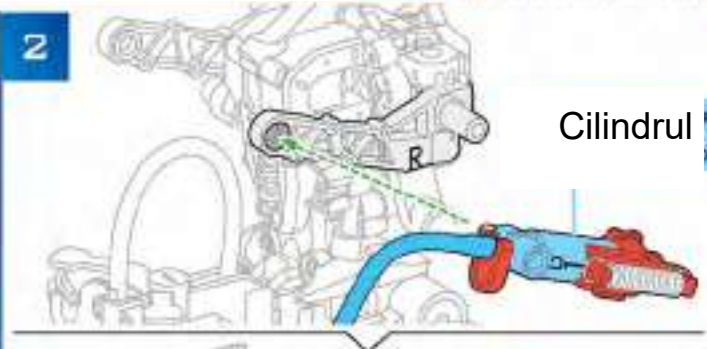

Bratul drept

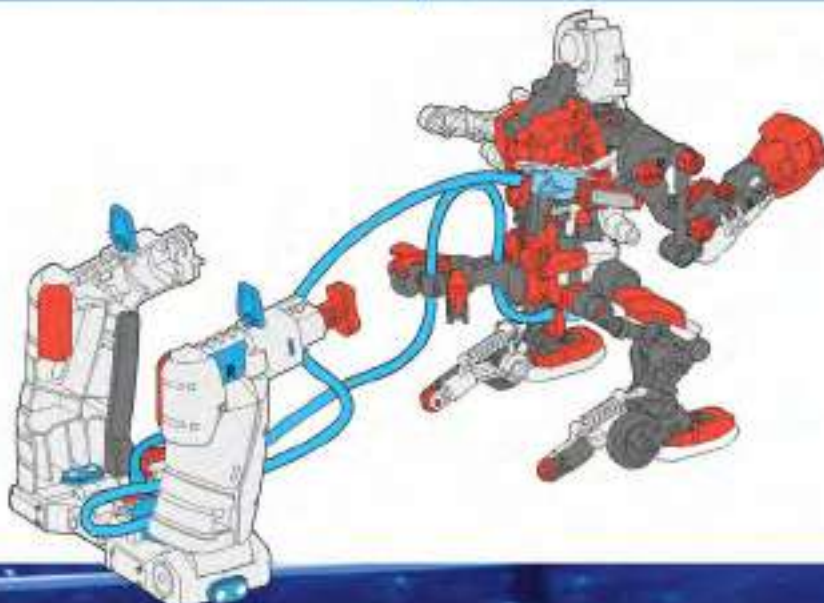
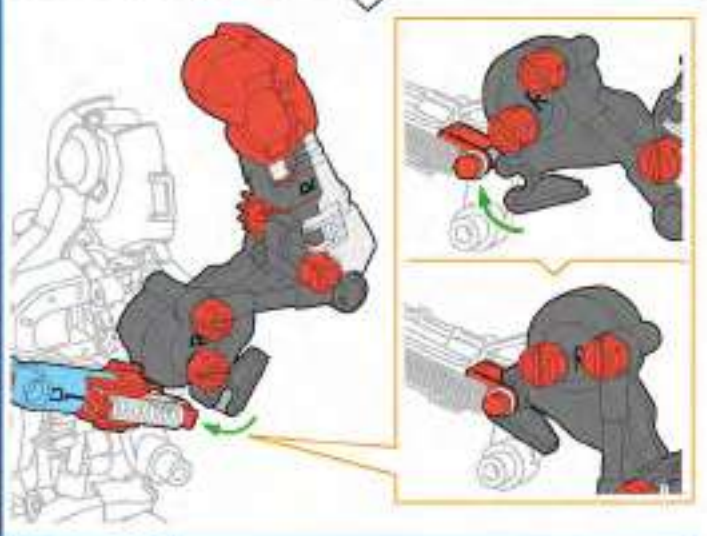

3

Maner stang

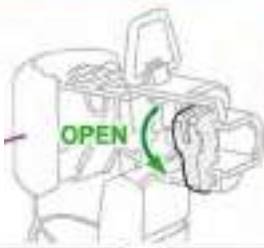

Deschideti

Cilindrul

D3

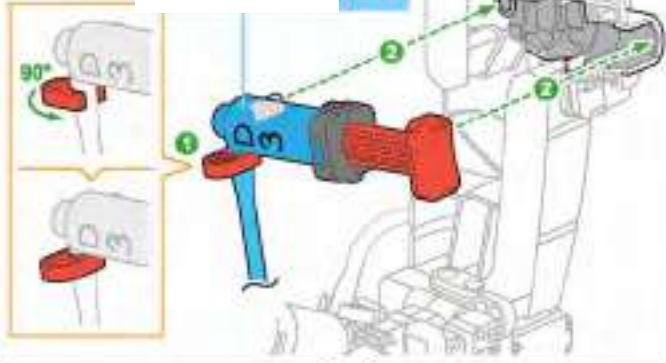

Inchideti

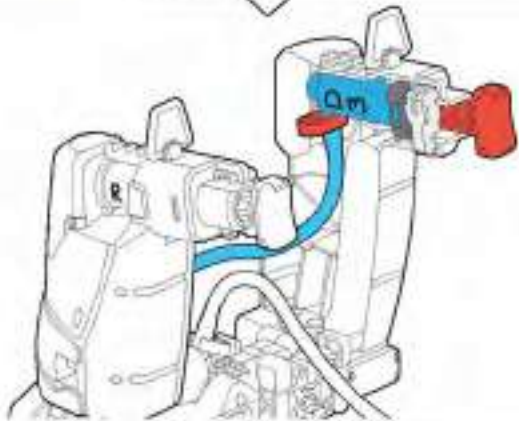
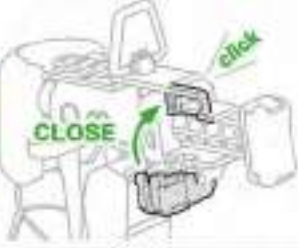

4

Cilindrul

D1

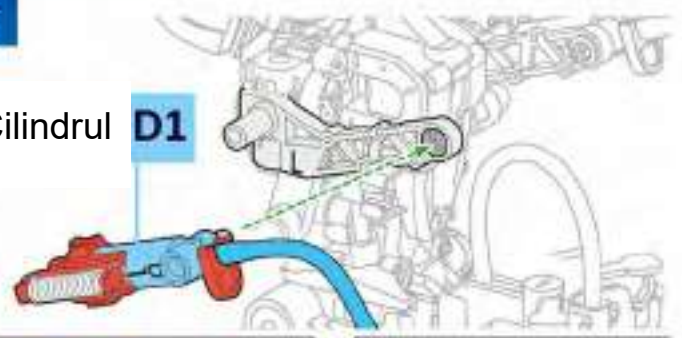

Bratul stang

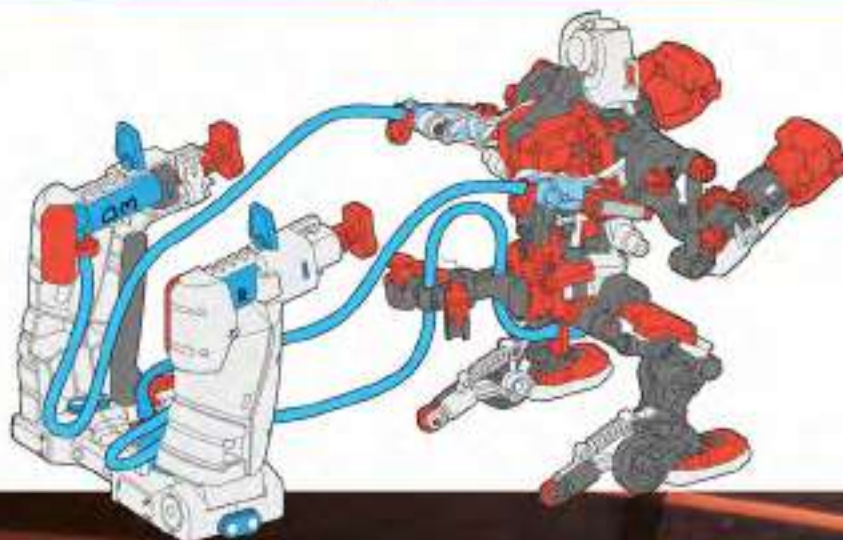
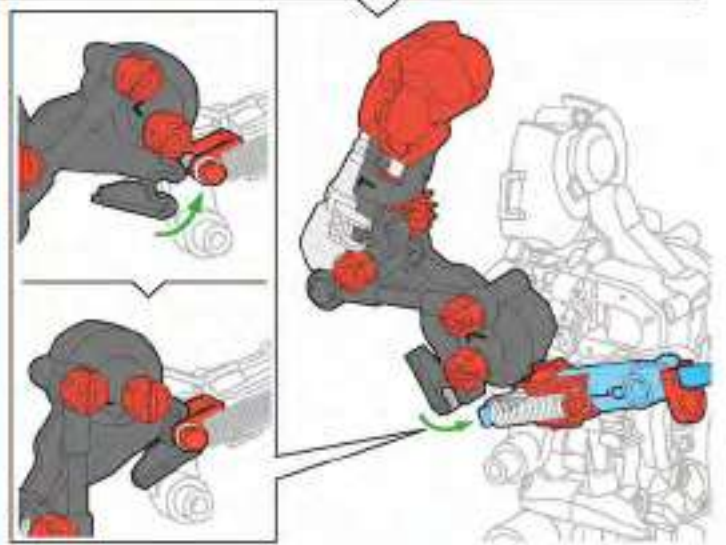
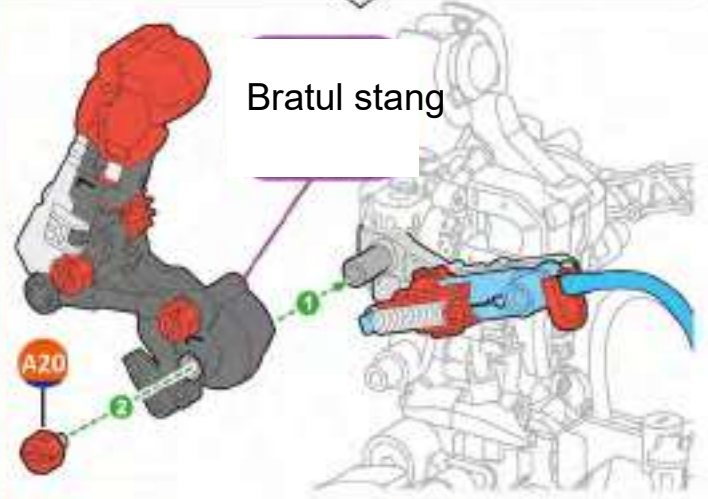

ARANJATI TUBURILE

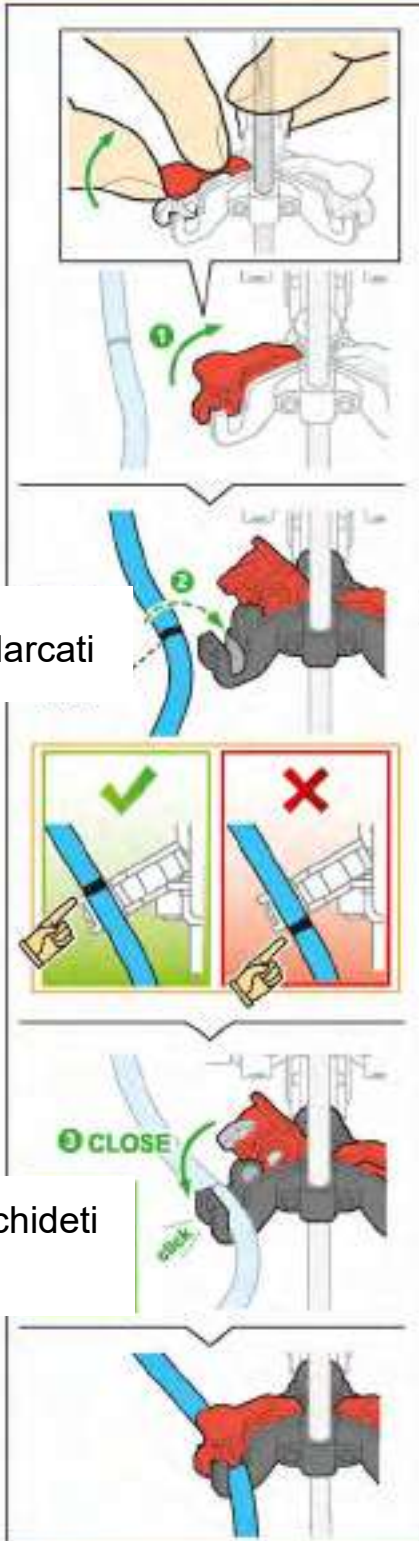

Marcati

Inchideti

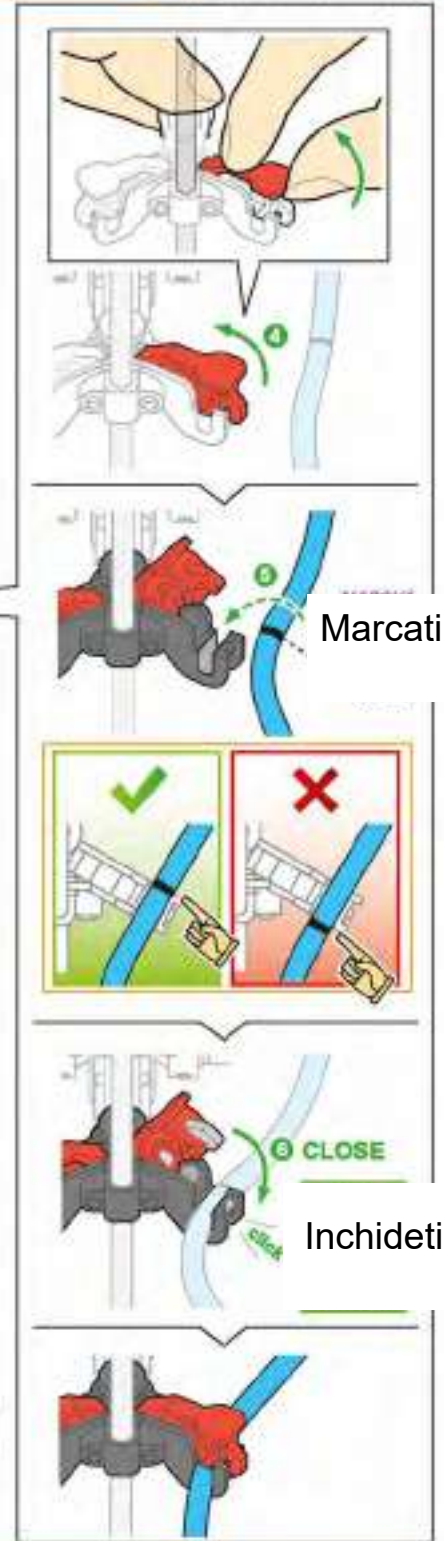
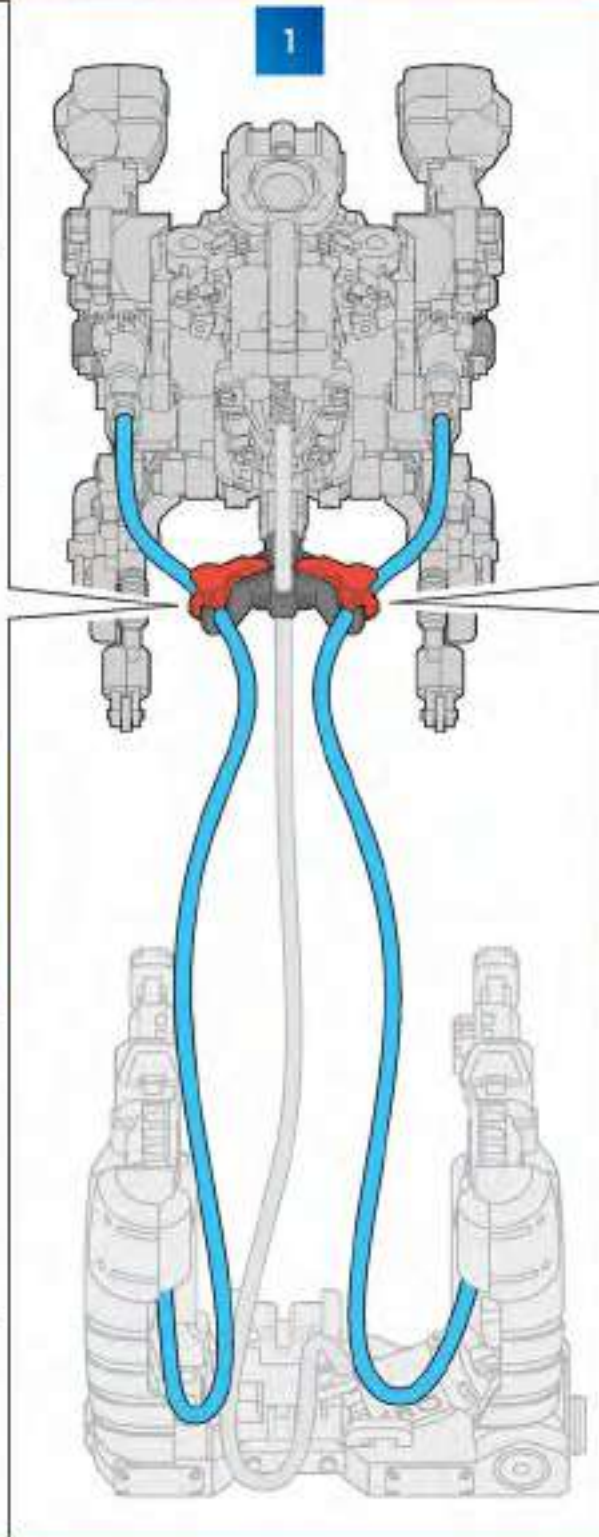

Marcati

Inchideti

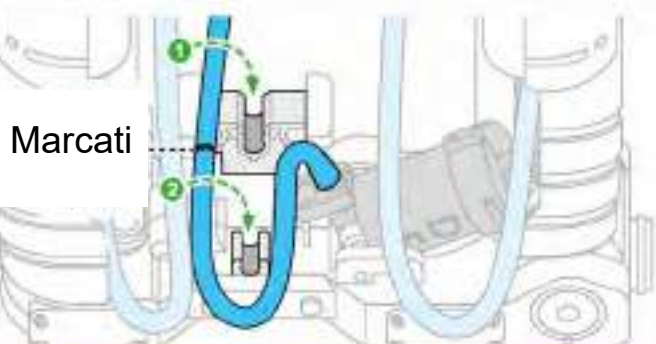
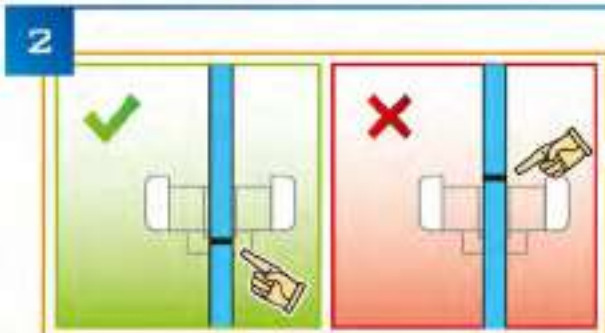

Marcati

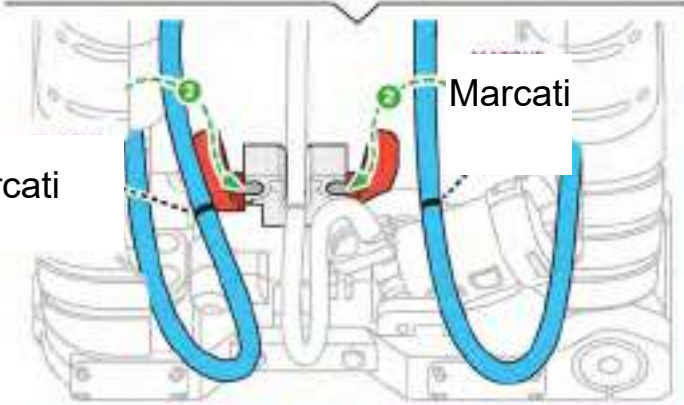
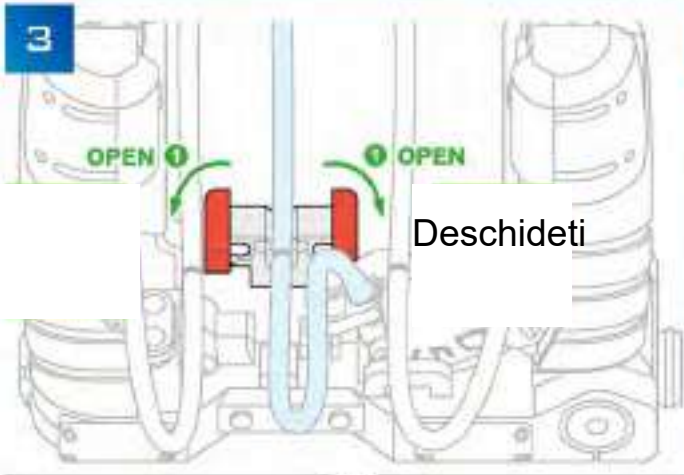

Marcati

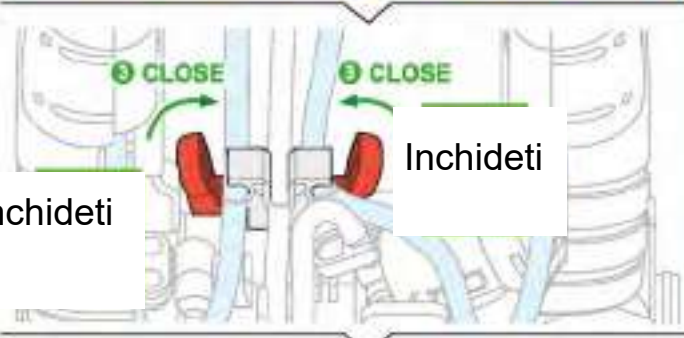
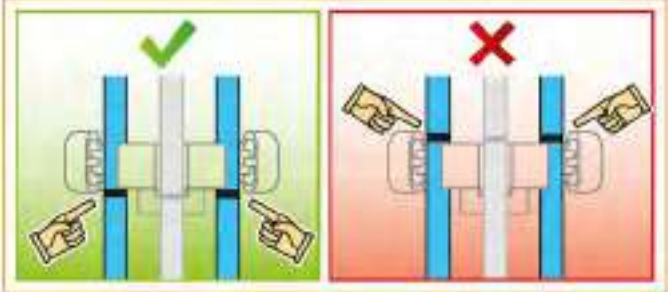

Inchideti

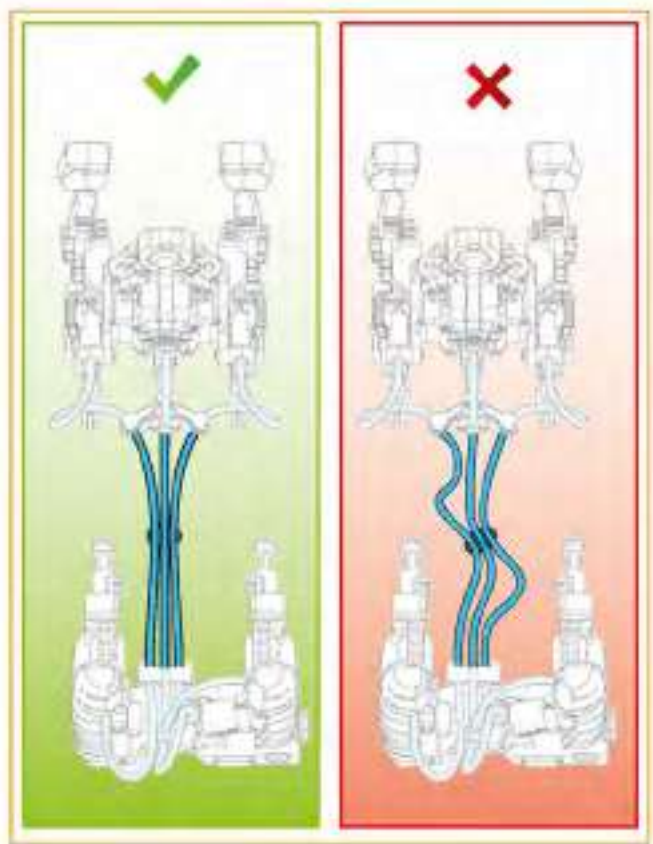
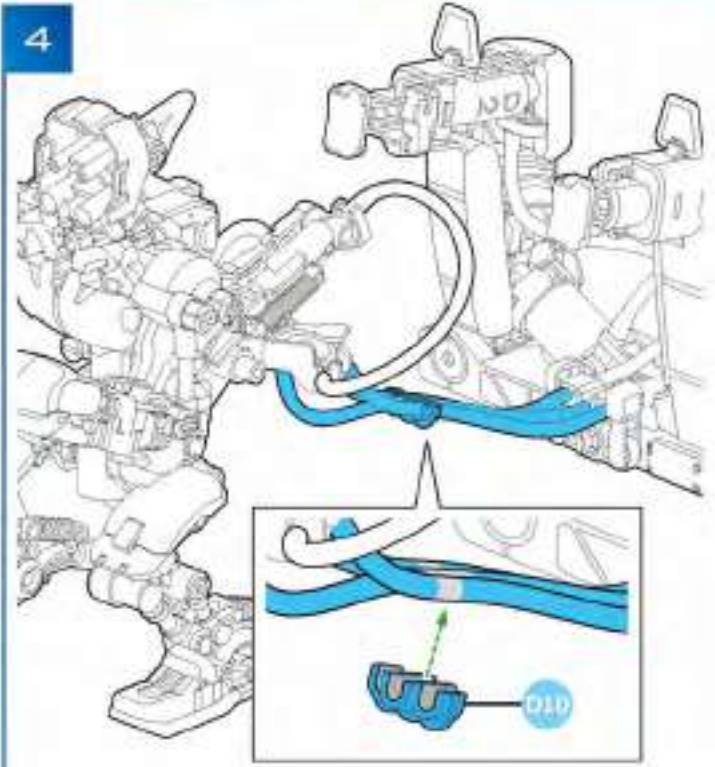
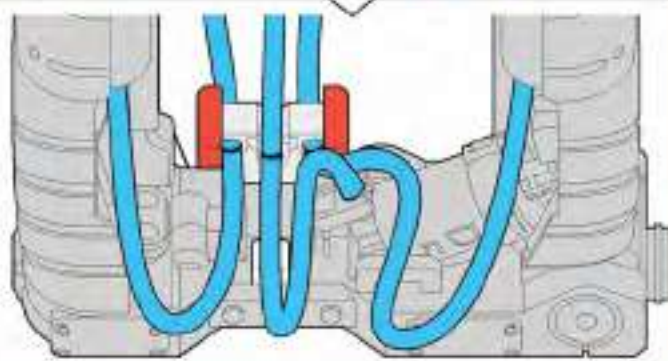

SCHIMBATI CAPUL BOXERULUI

ROBOT

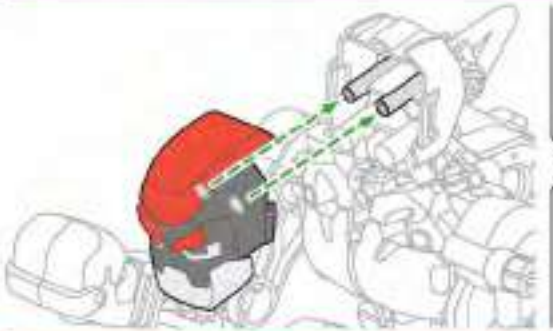

Cu o mana apasati capul robotului si scoateti piesa C20 cu cealalta mana.

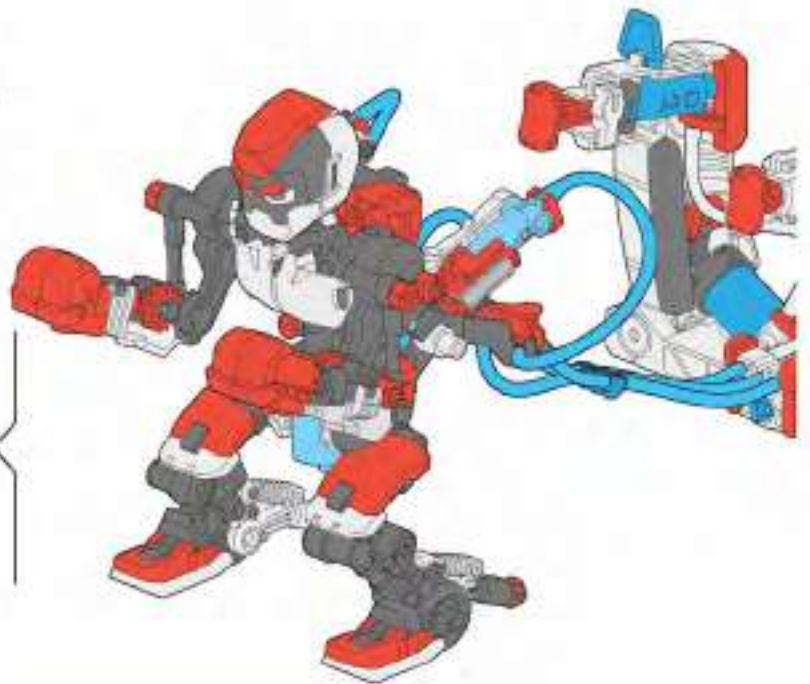
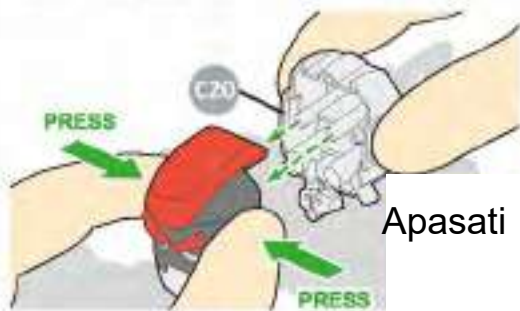

CANGUR

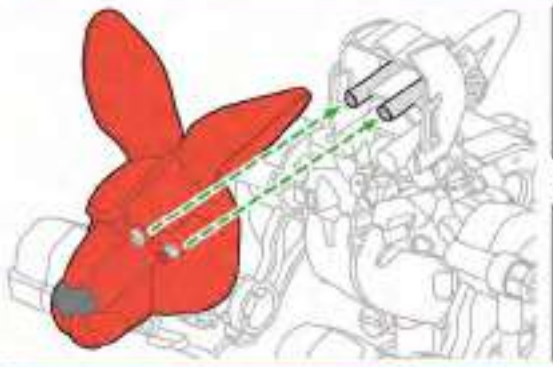

Cu o mana apasati capul cangurului si scoateti piesa C20 cu cealalta mana.

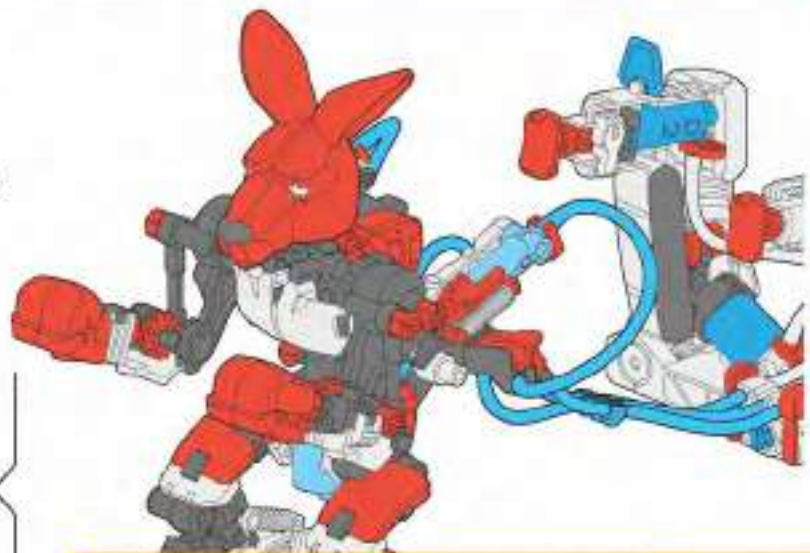

Asamblarea boxerului portocaliu este gata. Mergeti inapoi la pagina 6 pentru a incepe asamblarea boxerului albastru.



SCHIMBAREA MODULUI DE ATAC



UPPERCUT → PUMN

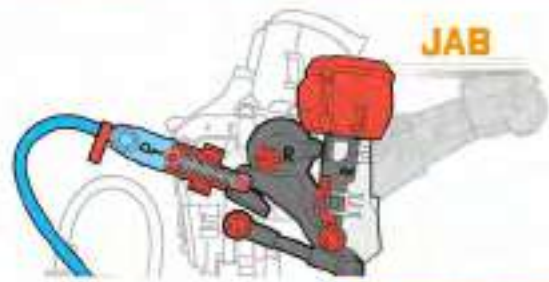

PUMN → UPPERCUT

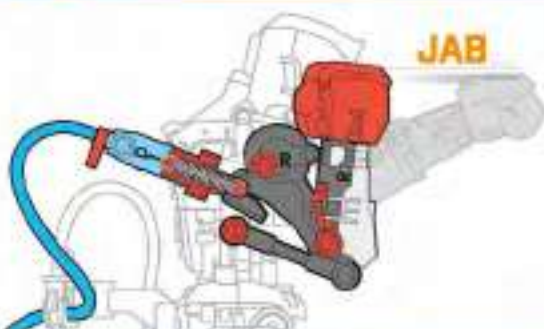
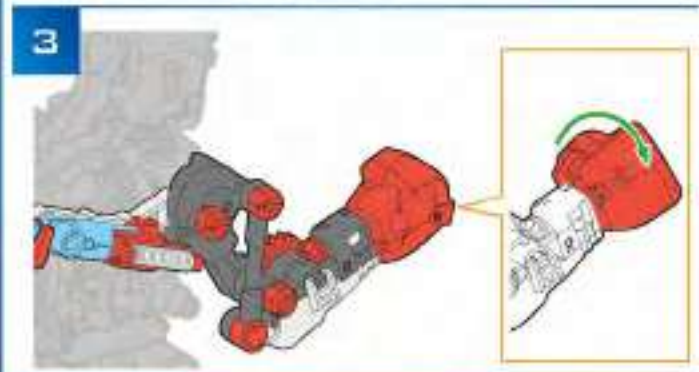
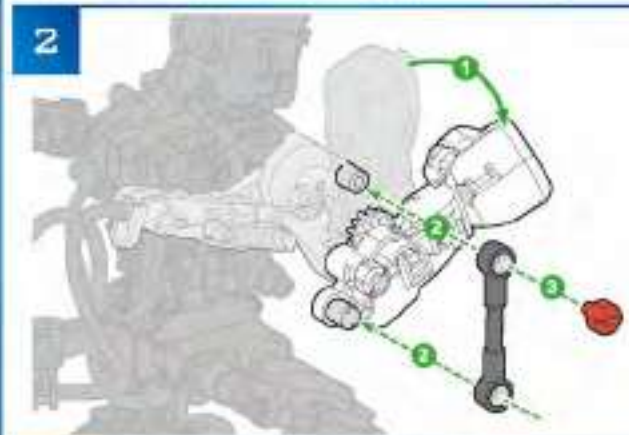
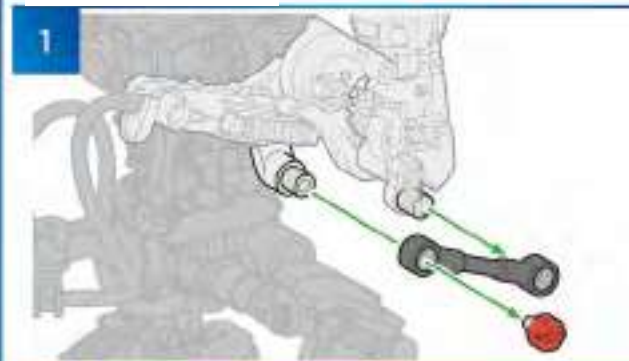
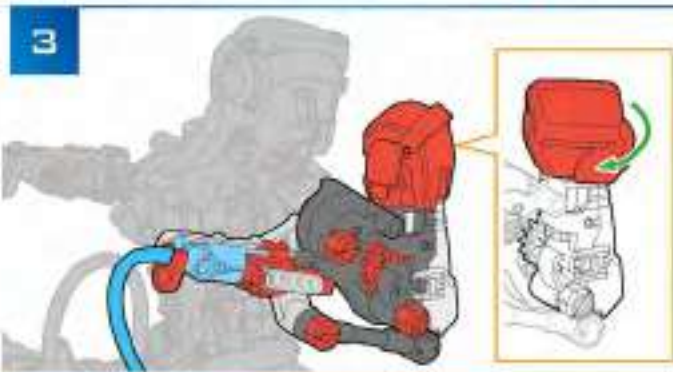
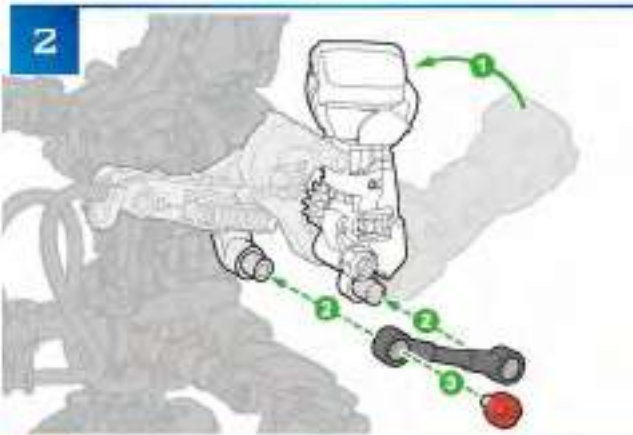
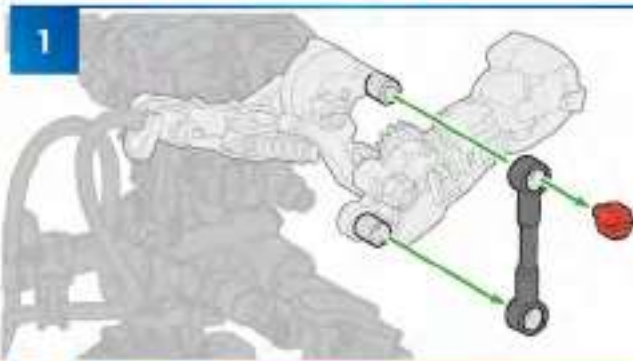

INSTRUCTIUNI DE JOC

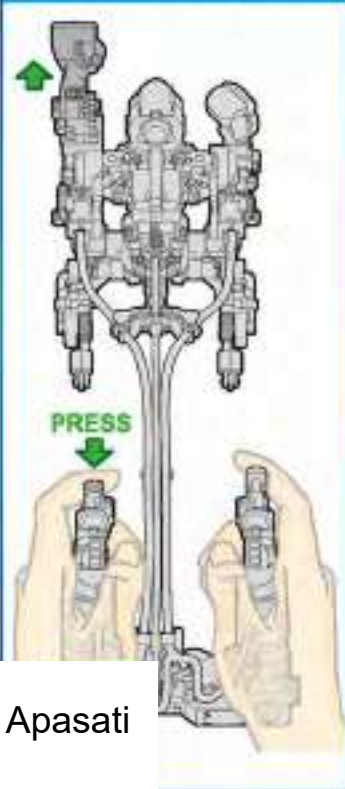
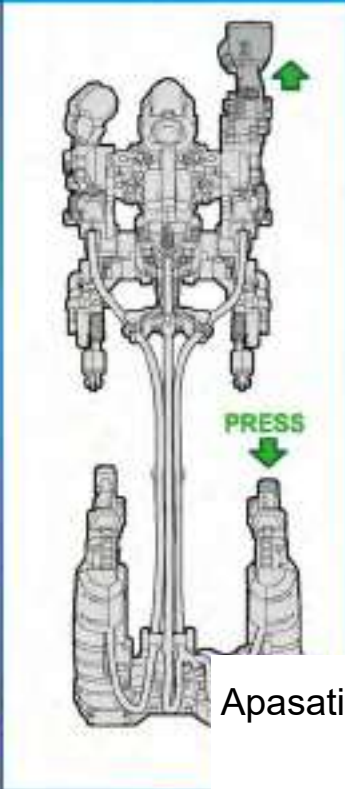
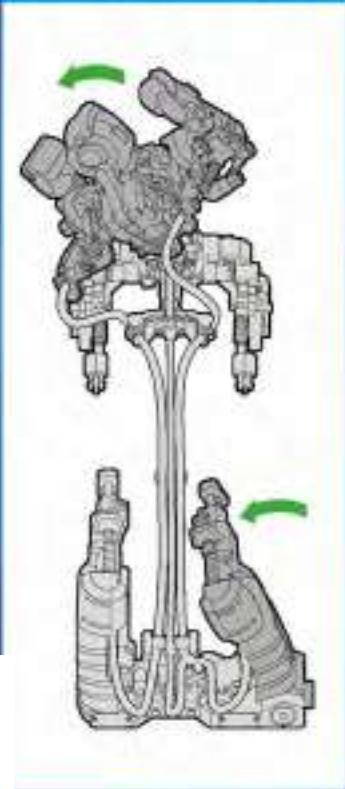
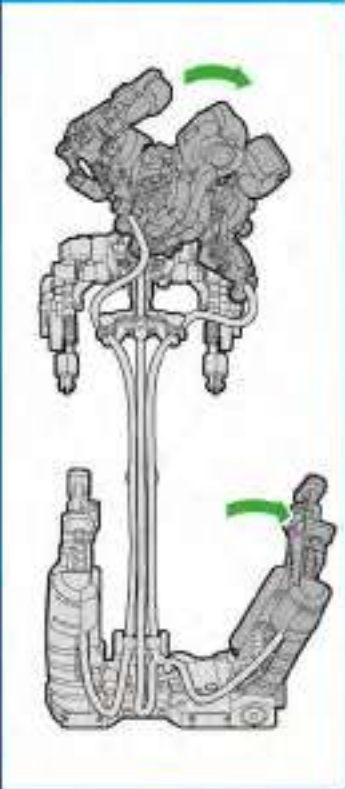

Lovitura de stanga	Lovitura de dreapta	Eschiva la stanga	Eschiva la dreapta
 <p>Apasati</p>	 <p>Apasati</p>		

Mutati boxerul

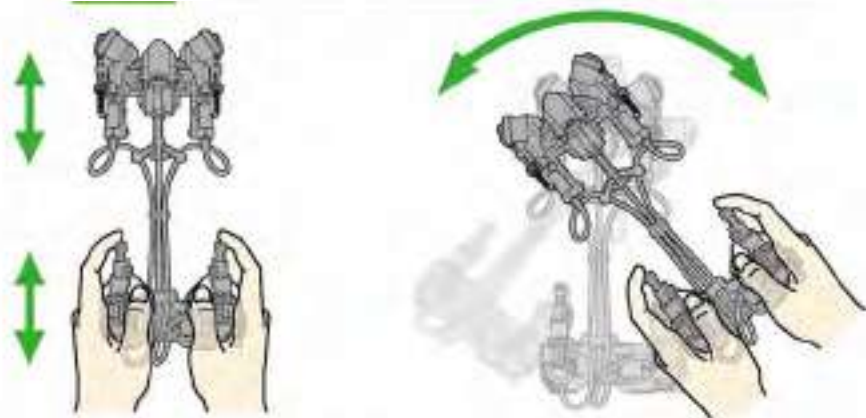

Reglati boxerul

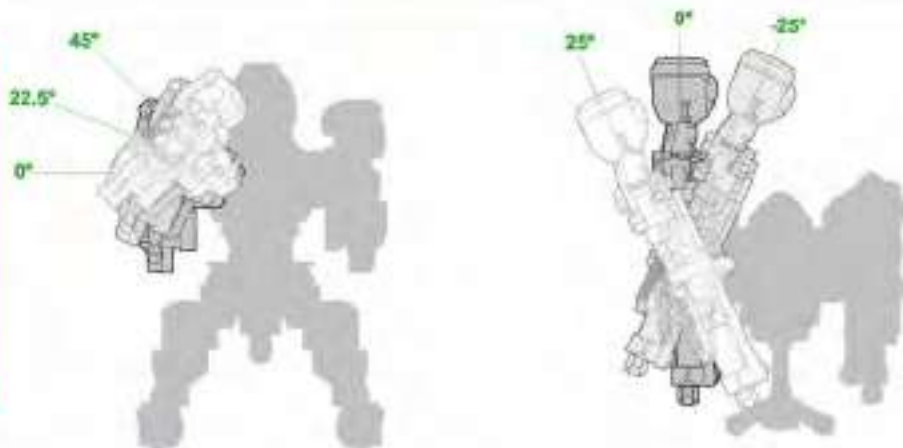

PREGATITI DE LUPTA?



Lovitura la cap- Knock out

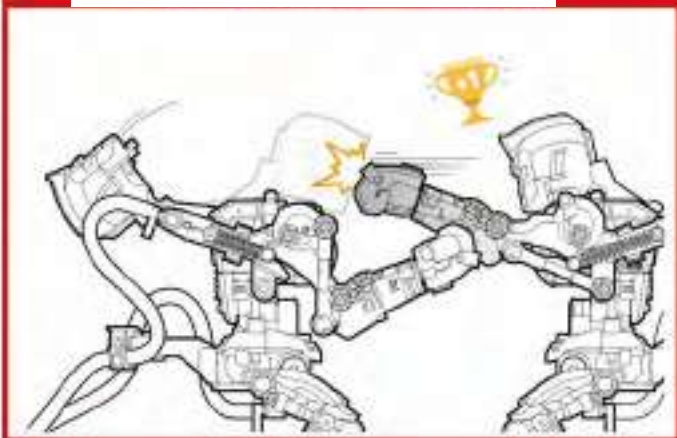

Doborati adversarul



Primul care ajunge la 6, castiga meciul!



Atentie!



1

Nu apucati corpul luptatorului in timp ce el boxeaza!



PRESS

Apasati

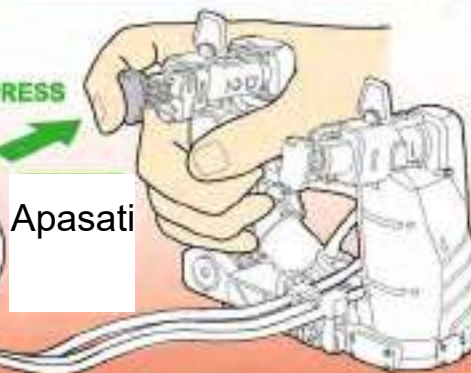

2

Nu indoiti prea mult manerul controller-ului



3

Nu trageți de picioarele boxerului

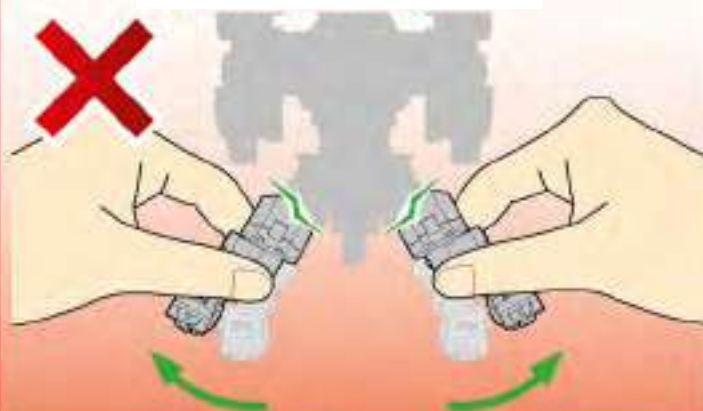

SFATURI PENTRU LUPTA



Robotul evită cu ușurință
loviturile uppercut

...dar nu și pumnul direct.

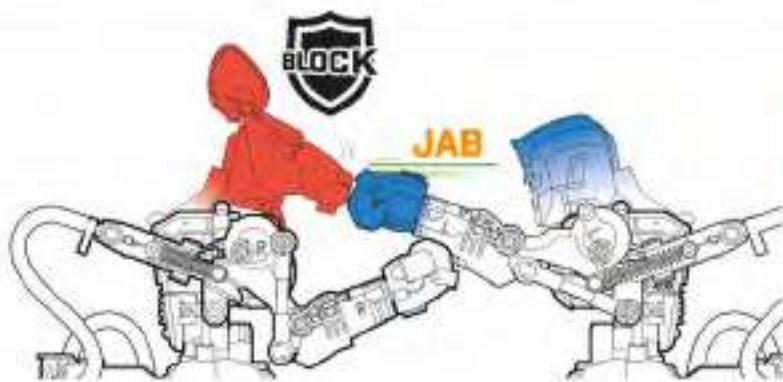
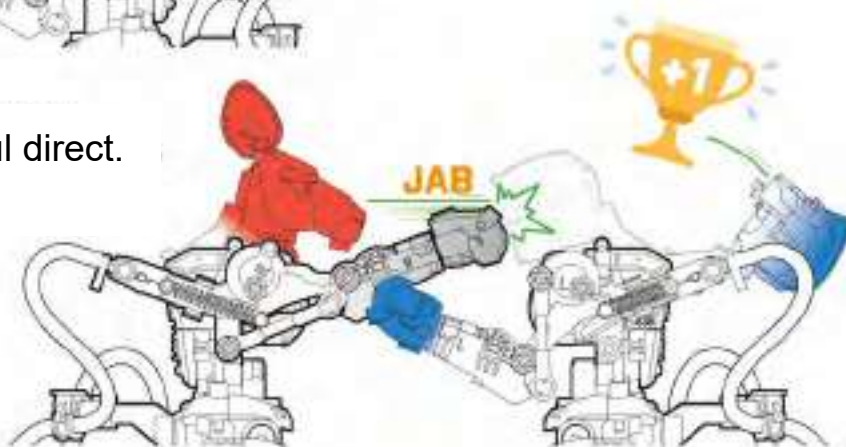

Cangurul rezista pumnilor

...dar nu se descurca la fel
de bine cu loviturile
uppercut



REZOLVAREA PROBLEMELOR



Daca boxerii nu functioneaza corespunzator, posibil sa aiba prea mult aer in sistemul hidraulic. Iata ce trebuie facut:

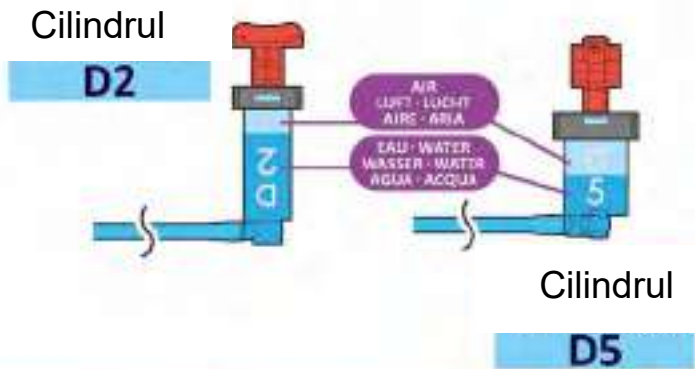

D2

Cilindrul D2
Valabil si pentru cilindrul D3

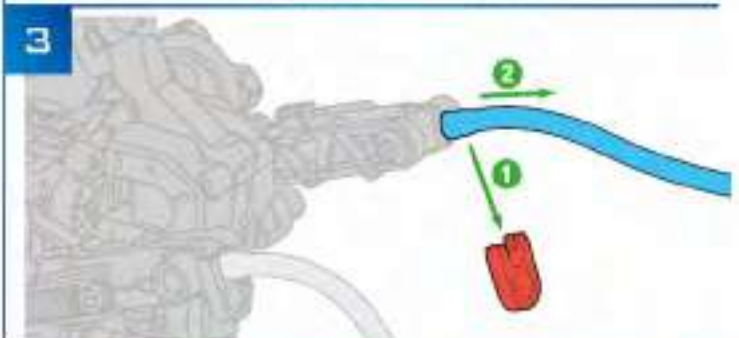
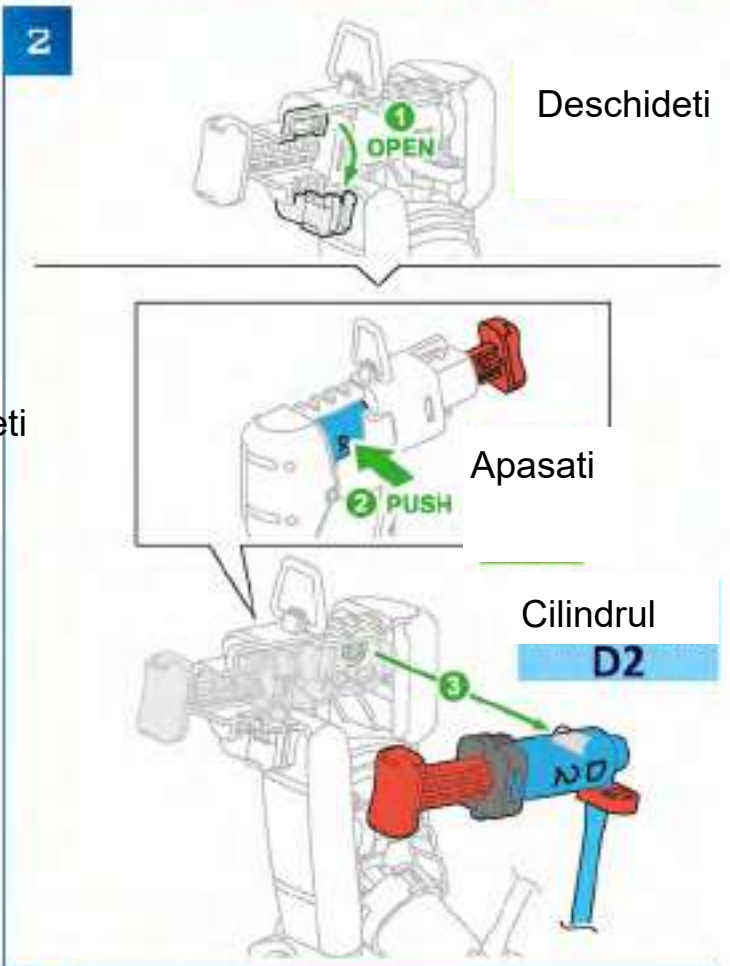
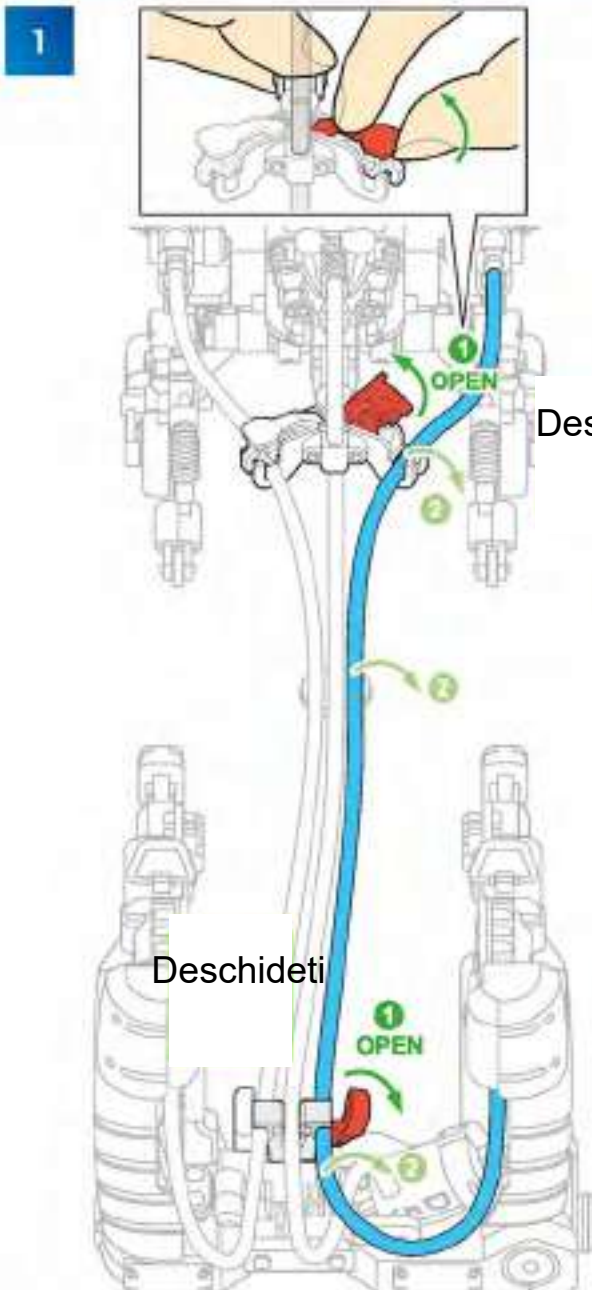

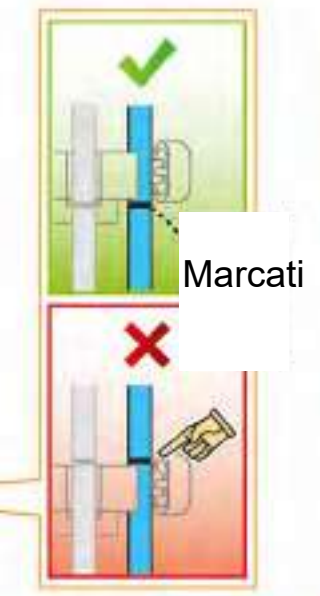
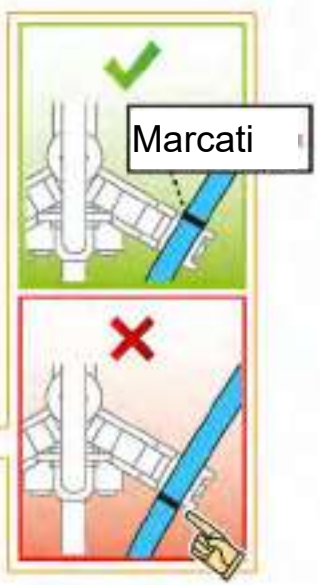
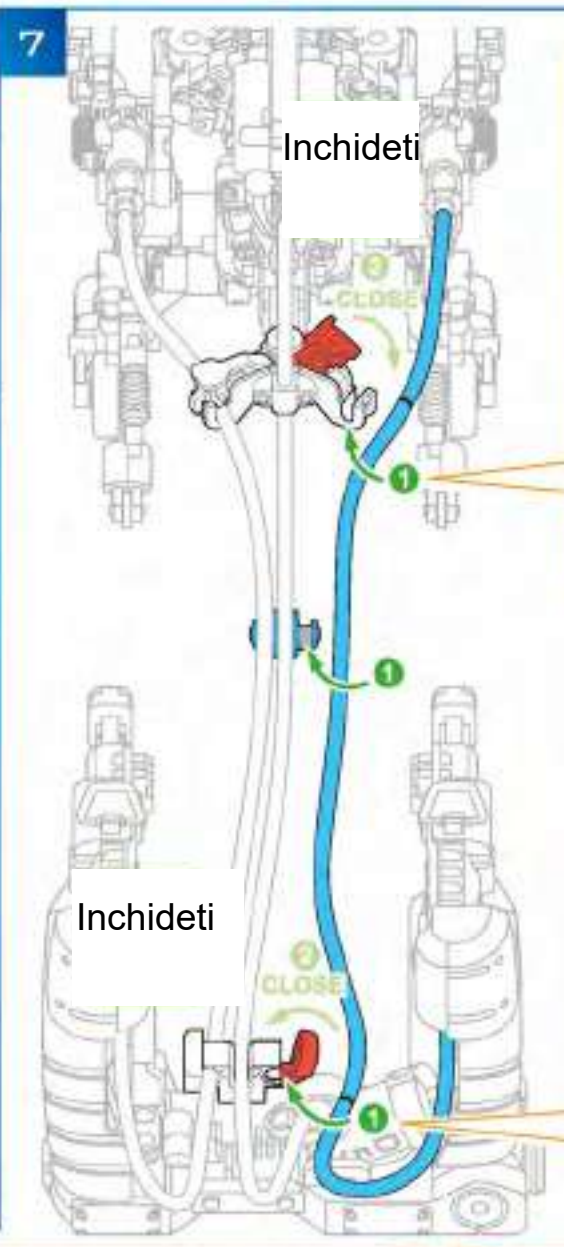
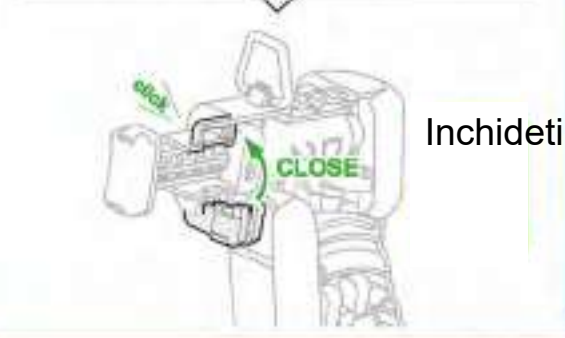
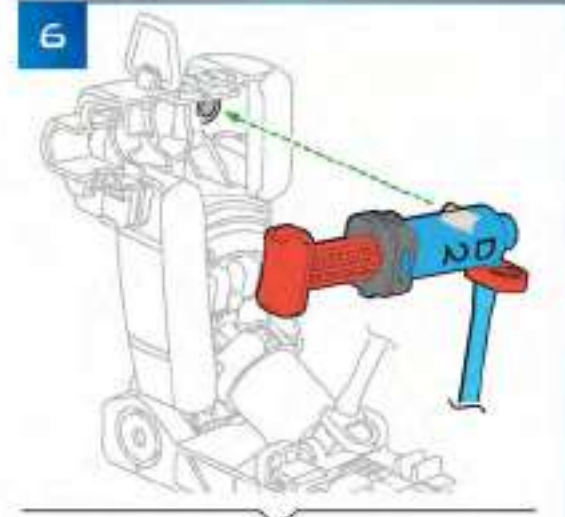
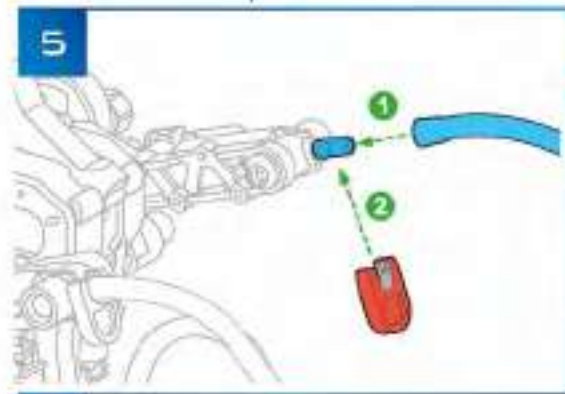
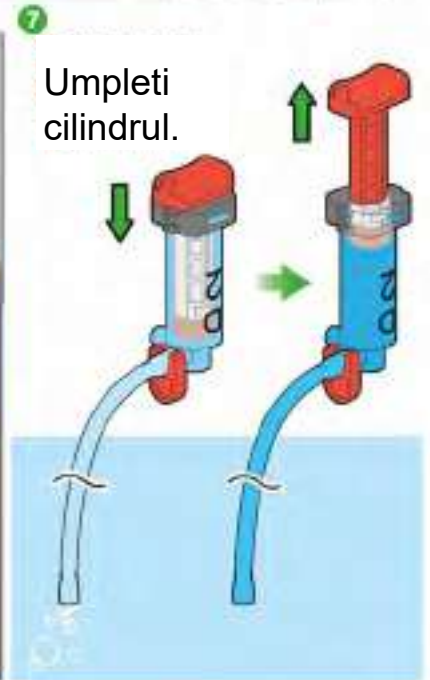
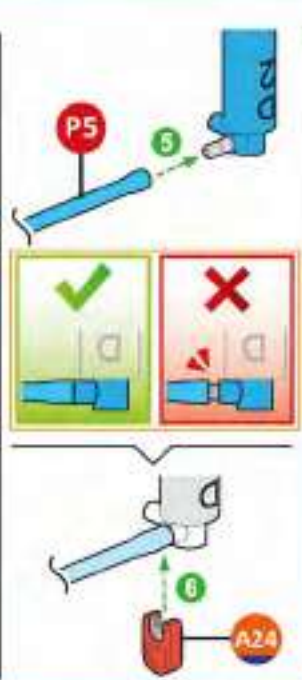
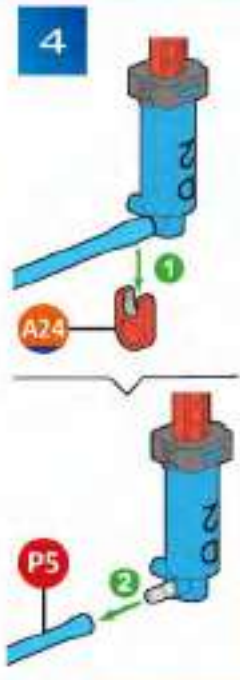



4

Probleme?
Mergeti inapoi la pasul 10
si asigurati-va ca pistonul
este impins complet in
timpul asamblarii.

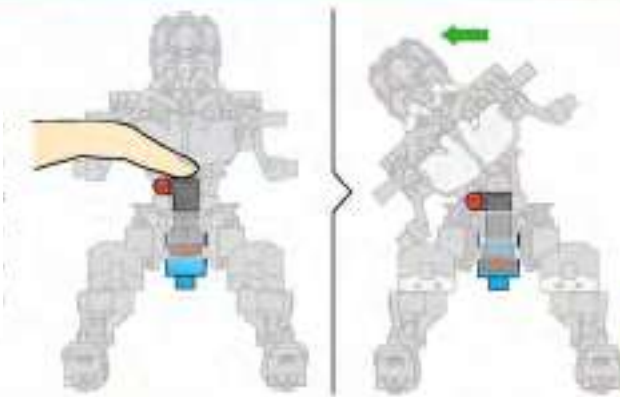

Atentie la
marcaj!

5

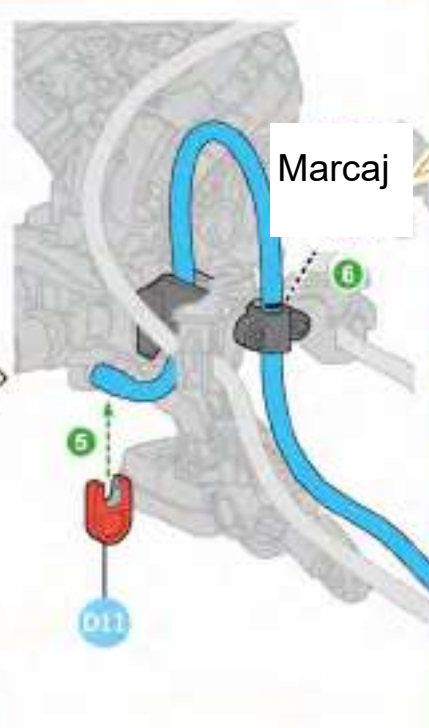
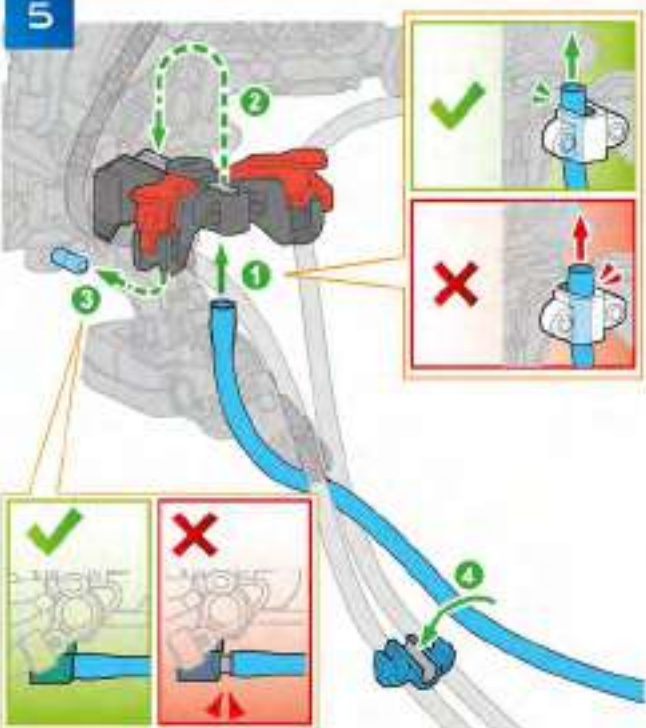

Impingeti
tubul inainte

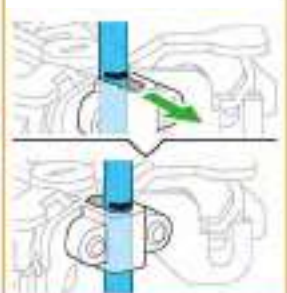

6



Marcati

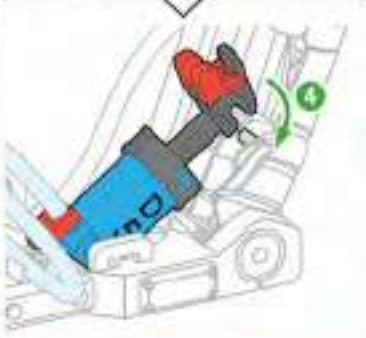
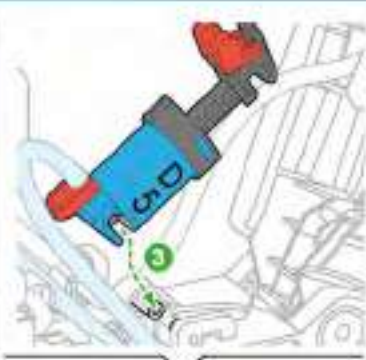
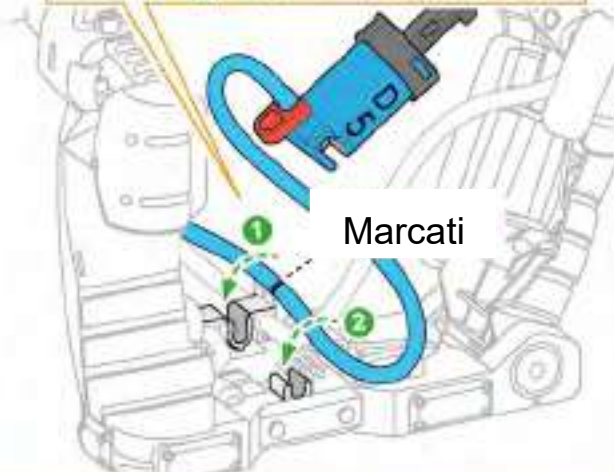

Varsta recomandata: 8 ani+

AVERTISMENT: Nu este recomandat copiilor mai mici de 8 ani din cauza pieselor mici care ar putea fi ingerate. Risc de sufocare.

AVERTISMENT: A se folosi sub directa supraveghere a unui adult. Prezenta marginilor ascutite si functionale.

Pastrati ambalajul pentru referinte viitoare. Culorile si continutul pot varia usor.



Produs si distribuit de:
BUKI France
38 av. François Mitterrand 72000
Le Mans - FRANCE
Tél: +33 1 46 65 09 92
E-mail : sav@bukifrance.com
www.bukifrance.com

